

## AXF 217S: Motorised actuator for unit valves with positioner

### How energy efficiency is improved

Automatic adaptation to valve and intelligent cut-off for maximum energy efficiency

### Features

- Stepping motor with electronic activation and cut-out
- Attached to valve with M30 × 1.5 thread
- Version with direction of operation 1 (direct acting) or 2 (reverse acting), adjustable
- Adjustable valve strokes
- Automatic stroke adjustment
- Electrical reset function
- Maintenance-free gear unit
- Suitable for retrofitting existing installations using the appropriate adapters
- Status and diagnostic indicator via integrated bi-colour LED
- Fitting position vertically upright to horizontal, not suspended



AXF217SF404

AXF217SF405



### Technical data

#### Power supply

Power supply	24 V~ ±15%, 50...60 Hz 24 V= ±15%
Power consumption	5 VA while charging, 2,5 VA during operation, 1 W at standstill

#### Parameters<sup>1)</sup>

Direction of operation	1 or 2 (adjustable)
Nominal stroke	Max. 6 mm Automatic stroke adjustment
Running time	8 s/mm
Closing dimension	H0:10 mm
Actuating power	160 N
Sound pressure level	< 30 dB (A)
Control signal	0(2)...10 V; 5...10 V; 0...5 V R <sub>i</sub> > 100 kΩ; 0(4)...20 mA R <sub>i</sub> = 500 Ω
Feedback signal	0...10 V=, ±5%
Charging time	150 s (supercapacitor)

#### Ambient conditions

Ambient temperature	0...50 °C, no condensation
Max. operating temperature at valve	95 °C
Storage and transport temperature	-20...65 °C
Ambient humidity	< 90% rh

#### Construction

Weight	0.2 kg
Housing	Two-piece, light grey (RAL 7035)
Housing material	Plastic
Thread	Nickel-plated brass M30 × 1.5
Power cable	1.50 m long, halogen-free 4 × 0.5 mm <sup>2</sup> , light grey, insertable

#### Standards, directives

Type of protection	IP54 (EN 60529)
--------------------	-----------------

<sup>1)</sup> The direction of operation and the control voltage can be set using accessory 0550360010 (configurator); factory setting "1" (DA). Direction of operation 1: Control signal increasing = actuator moves out (valve VUT, VUL, VXL, VDL, BUL, BUT closes, valve BXL (control passage) opens). Direction of operation 2: Control signal increasing = actuator moves in (valve VUT, VUL, VXL, VDL, BUL, BUT opens, valve BXL (control passage) closes)

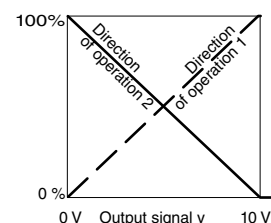

	Protection class	III (IEC 60730)
CE conformity according to	EMC Directive 2014/30/EU	60730-1, 60730-2-14

#### Overview of types

Type	Features
AXF217SF404	Motorised actuator for unit valves with positioner, automatic stroke adjustment, electrical reset function: Spindle extends (EFSD)
AXF217SF405	Motorised actuator for unit valves with positioner, automatic stroke adjustment, electrical reset function: Spindle retracts (EFSU)

#### Accessories

Type	Description
0550360010	Configurator for changing control signal, direction of operation, characteristic, direction of reset function
0371235001	Adaptor for fitting to Oventrop valves (M30 × 1)
0550393002	Adapter for fitting to Danfoss valves, type RAVL, 26 mm
0550393003	Adapter for fitting to Danfoss valves, type RAV, 34 mm
0371356001	Adaptor for fitting to Beulco or Tobler underfloor-heating distributors (M30 × 1)
0371361001	Adapter for fitting to Herz valves, type Herz-TS'90 (M28 × 1.5)
0371363001	Adapter for fitting to Tour & Andersson valves, type TA/RVT (M28 × 1.5)
0550393004	Adapter for fitting to Danfoss valves, type RA 2000, 22 mm

### Description of operation

**Reset function:** The actuator is equipped with an electrical capacitor which in the event of a power failure (> 1 s) has enough power to move the actuator and valve to a predefined position (open or closed). The nominal speed of the reset function is 8 s/mm.

When the power supply is restored, the capacitor is charged (150 s) and the automatic stroke detection routine is carried out. After this, the actuator is ready for normal operation again. The electrical reset function is designed for a guaranteed serviceable life of 5,000 full charges.

**Auto-calibration:** To detect the valve stroke, the actuator moves the spindle all the way to both end positions after the operating voltage is applied. By measuring the position of the spindle, the total stroke of the valve is calculated and stored in the actuator. As soon as the calibration cycle (red LED flashes slowly) is completed, the actuator changes to normal mode (constant green LED). Then the spindle moves to the position that corresponds to the control signal.

#### Note



To function properly, the actuator requires a valve with a preloading of at least 2 kg. The actuator performs an auto-calibration every time it is switched off and on again.

Direction of operation 1:

- As the positioning signal increases, the actuator spindle extends and the VUT, VUL, VXL, VDL 2-way valves and the BUL, BUT 3-way valves (control passage) close. With the BXL 3-way valve, the control passage opens.

Direction of operation 2:

- As the positioning signal increases, the actuator spindle retracts and the VUT, VUL, VXL, VDL 2-way valves and the BUL, BUT 3-way valves (control passage) open. With the BXL 3-way valve, the control passage closes.

### Configurator

The connection for the configurator (accessory 0550360010) is below the removable housing cover. The following settings can be made using the configurator:

- Setting of the input signal. This can be set to either 0...10 V or 5...10 V or 0...5 V.
- Selection of direction of operation 1 (direct acting) or 2 (reverse acting). Factory setting: Direction of operation 1.
- Selection of the "linear" or "equal percentage" characteristic. Factory setting: "Linear".
- Selection of the direction of the electrical reset function:
  - Spindle extends (EFSD) for AXF217SF404 ex works
  - Spindle retracts (EFSU) for AXF217SF405 ex works

The cap must be put back on after the adjustment.

### Confirmation of end position

The actuator is readjusted every two hours if it has been in the end position for more than two hours (100% extended).

### Intended use

This product is only suitable for the purpose intended by the manufacturer, as described in the "Description of operation" section.

All related product regulations must also be adhered to. Changing or converting the product is not admissible.

### Improper use

The AXF 217S may not be relied upon for functional safety and is not fail-safe.

This product is not suitable:







- For safety functions
- For plants of categories 1 to 4 as per Pressure Equipment Directive 2014/68/EU

### Combination with non-SAUTER valves

JCI	Danfoss	Frese	Industrie Technik	Oventrop
<ul style="list-style-type: none"> <li>• VG3000 series</li> <li>• V5000 series (discontinued)</li> <li>• VG6000 series (discontinued)</li> <li>• VP1000 series</li> </ul>	<ul style="list-style-type: none"> <li>• AB-QM (DN10–DN32)</li> </ul>	<ul style="list-style-type: none"> <li>• Optima Compact 53–13xx, 2.5 mm (DN10–DN20)</li> <li>• Optima Compact 53–13xx, 5.0 mm (DN10–DN20)</li> <li>• Optima Compact 53–13xx, 5.5 mm (DN25–DN32)</li> </ul>	<ul style="list-style-type: none"> <li>• VFX series (DN15–DN20)</li> </ul>	<ul style="list-style-type: none"> <li>• COCON QTZ (DN10–DN32)</li> <li>• COCON 2TZ (DN15–DN20)</li> <li>• Tri-M Plus</li> </ul>

Schneider Electric	Siemens	TA Hydraulics	Fratelli Pettinaroli	Watts Industries
<ul style="list-style-type: none"> <li>• VZx8 VZx8C series (DN15–DN20)</li> </ul>	<ul style="list-style-type: none"> <li>• VVP47 series</li> <li>• VXP47 series</li> <li>• VMP47 series</li> <li>• VVI46 series</li> <li>• VXI46 series</li> <li>• VVS46 series</li> <li>• VXS46 series</li> </ul>	<ul style="list-style-type: none"> <li>• TBV-C (DN15–DN20)</li> <li>• TBV-CM (DN15–DN25)</li> <li>• TBV-CMP (DN15–DN25)</li> <li>• KTCM512 (DN15–DN25)</li> <li>• TA Compact (DN10–DN32)</li> <li>• TA Modulator (DN15–DN20)</li> </ul>	<ul style="list-style-type: none"> <li>• 91 series</li> <li>• 92 series</li> <li>• 93 series</li> </ul>	<ul style="list-style-type: none"> <li>• 2131 series</li> <li>• 3131 series</li> <li>• 4131 series</li> </ul>

### LED status indicator

Status	Display	Description
Off		No power applied
Simultaneously flashing red, green, blue		Actuator not configured
Flashing green		Actuator moving to position or end position reached
Continuous green		Position reached
Slowly flashing red		Calibration cycle
Rapidly flashing red		Temporary fault, valve possibly stuck

Status	Display	Description
Continuous red	●	No input signal
Slowly flashing blue	●	Supercapacitor in operation, failsafe active
Rapidly flashing blue	●	Supercapacitor has reached end of its lifetime
Continuous blue	●	Charging supercapacitor

**Engineering and fitting notes**

Do not use tools to fit the actuator to the valve. If the power fails, the supercapacitor closes or opens the valve. When connecting or changing the power cables, the mains power must be switched off. The actuator may be fitted to the valve only when the actuator spindle is not fully (100%) moved out. Factory setting: 0% stroke.

**Fitting position**

The actuator may not be fitted upside down.

**Outdoor installation**

If installed outside, the device must be protected from the weather.

**Disposal**

When disposing of the product, observe the currently applicable local laws. More information on materials can be found in the Declaration on materials and the environment for this product.

**Connection diagram**

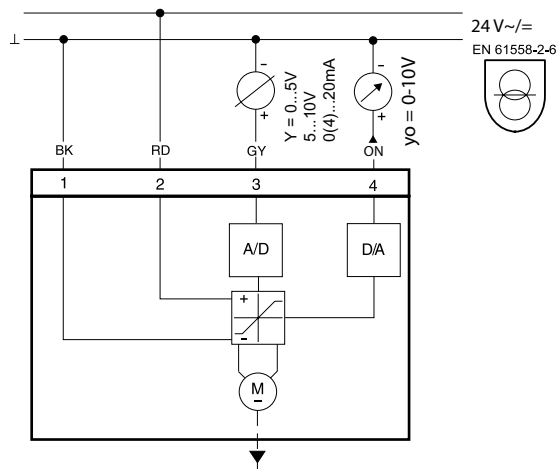

Connection	Colour code	Wire colour
1	BK	Black
2	RD	Red
3	GY	Grey
4	ON	Orange

## Dimension drawing

All dimensions in millimetres.

