

EY6AS80: Modular BACnet automation station and web server, modu680-AS

Features

- Part of the SAUTER modulo 6 system family
- Modular automation station, expandable with I/O modules and communication modules
- Regulation, control, monitoring and optimisation of operational systems in HVAC
- Locally expandable with up to 24 modules via the SAUTER Extension Bus
- Can be locally equipped with ecoLink I/O modules and ASV actuators via SLC interface
- RS-485 interface for field bus integration (Modbus/RTU / ASCII)
- Four RJ45 connections for two separate IP networks (OT/IT; Operational/Information Technology).
Three connections switched for daisy chain
- BACnet/IP communication (EN ISO 16484-5)
- BACnet profile B-BC
- AMEV profile AS-B
- REST API interface
- MQTT interface (MQTT Broker/Client)
- Integrated web server for local commissioning, visualisation and operation
- User administration for identification, authentication and access control
- Encryption of communication with TLS
- Bluetooth interface for mobile commissioning and maintenance
- Programming/parameterisation via PC using CASE Suite (based on IEC 61131-3)
- Control libraries
- Time and calendar function
- Predictive control based on meteorological forecast data
- Data recording on removable media (microSD card)
- User administration and user identification (web server)
- Alive signal output pulsed



EY6AS80F021



Technical data

Power supply		
Power supply		24 VDC ± 10%
Power consumption ¹⁾		≤ 2 W without load ≤ 24 W at maximum load
Dissipated power		≤ 2 W without load ≤ 4 W at maximum load
Peak inrush current ²⁾		≤ 20 A, ≤ 1 ms on the 24 V side
Parameters		
Connection		5-pin spring-type terminal, pluggable, 0.5...1.5 mm ² (rigid) 0.5...2.5 mm ² , min. 8 mm wire strip- ped
Battery (buffer: RTC)		CR2032, pluggable
Earth connector		Spring contact against DIN rail and PE terminal
Ambient conditions		
Operating temperature		0...45 °C
Storage and transport temperature		-20...70 °C
Ambient humidity		10...90% rh, no condensation
Function		
BACnet	BACnet data point objects	Up to 1600 I/O objects, 3200 total
	BACnet client links	600 (Peer-to-Peer)
	Control	96 (Loop)
	Active COV subscription	4800

¹⁾ Maximum load with 12 I/O modules

²⁾ Measured value with EY-PS021F021 power supply unit



Dynamic objects	Structured view	128 (Structured View)
	Sequences, scenes	16 (Command)
	Time programmes	64 (Schedule)
	Calendar	32 (Calendar)
	Alarms	32 (Notification Class) intrinsically or extrinsically with Event Enrolment
	Historical data	1600 (Trend Log) up to 4 million entries
	BBMD in BDT	32
	FD in FDT	32
Services	Embedded web server	moduWeb Unity
	Web API (REST)	moduWeb Unity
	MQTT Broker/Client	MQTT/TCP(TLS), MQTT/WS
	Notification (client)	SMTP, SMPP
	Time synchronisation	NTP client, BACnet master or client, local or UTC
	Data integrity (client)	With modu615-BM
Architecture		
Architecture	Processor	ARM Cortex A8, 32-bit, 1 GHz
	RAM (memory)	512 MB (DDR3)
	Flash	512 MB
	Application data	Via CASE Engine
	Processes (BACnet programs)	Supports separated processes with different cycle times and independent booting
	Cycle time	Adjustable for each process, min. 50 ms (50, 100, 500, 1000)
	Interfaces, communication	
Ethernet network #1 (WAN)	Communication protocols	HTTP(S), NTP, SMTP, SMPP, DHCP, MQTT
	Ethernet network	1 × RJ45 connector
	10/100 BASE-T(X)	10/100 Mbit/s
Ethernet network #2 (LAN)	Communication protocols	BACnet/IP (DIX), HTTP(S), NTP, SMTP, SMPP, DHCP, MQTT
	Ethernet network	3 × RJ45 connector
	10/100 BASE-T(X) switched	10/100 Mbit/s
Connection, I/O and COM modules	Use ³⁾	1 × integrated iSEB interface for max. 12 modules, expandable with modu601-LC for max. 24 modules in total
RS-485 A connection	Communication protocol	Modbus/RTU / ASCII Modbus master according to V1.02
	Bus physics	1 unit load (UL), electrically isolated
	Bus speed	600...115,200 bit/s Parity bit, stop bit, Rx/Tx bus timing
	Connection	Spring-type terminal, pluggable 0.2...1.5 mm ² stiff/flexible
	Line ⁴⁾	3-/4-wire (D+/D-/COM reference), twisted, shielded, up to 1000 m
	Use	Integration of Modbus slaves in an RS-485 segment (line)
	Participant	Up to 31 RS-485 unit loads (UL)
	Functions	Up to 600 Modbus channels for BACnet I/O/V objects for up to 247 Modbus devices; FC01-06, 15, 16, 22; unicast and broadcast; access optimisation
	120 Ω bus termination and pull-up/pull-down	Switchable via software (CASE Engine)
	RS-485 B connection	Communication protocol
Use		ecoLink, ASV, ecoUnit, FCCP200

³⁾ Performance-dependent

⁴⁾ Performance-dependent

	Participant	Max. 8 ecoLink modules and 4 ecoUnit modules, max. 12 ASV units
	Power supply	20...26 V=, max. 1.5 W, protected against short circuit, can be switched on/off (CASE Sun)
	Connection	Spring-type terminal, pluggable 0.2...1.5 mm ² stiff/flexible
	Line	4-wire, twisted, shielded
	Line length	Max. 100 m (30 m) with ecoUnit or ASV, up to 500 m, bus termination necessary (120 Ω)
	120 Ω bus termination and pull-up/pull-down	Switchable via software (CASE Sun)
Bluetooth	Version	BLE 4.0
	Range	< 10 m
	Frequency band	2.402...2.480 GHz
	Radiation	6 mW
USB	Version	2.0, type A
	Current limitation	400 to max. 500 mA
SD memory expansion	Type	microSD, suitable for industrial use

Construction

Fitting	On metallic DIN rail 35 × 7.5/15 as per EN 60715. Rail housing as per DIN 43880
Dimensions W × H × D	92.6 (5 HP) × 100.9 × 58.3 mm
Weight	260 g

Standards, directives

Type of protection	Connections: IP00 Front in DIN cut-out: IP30 (EN 60730-1)	
Protection class	I (EN 60730-1)	
Environment class	3K3 (IEC 60721)	
Software class	A (EN 60730-1, Appendix H)	
Energy class	I to VIII = up to 5% as per EU 811/2013, 2010/30/EU, 2009/125/EC	
BACnet profile	B-BC (ISO 16484-5)	
AMEV profile	AS-B	
CE conformity according to	EMC Directive 2014/30/EU	EN 61000-6-1, EN 61000-6-2, EN 61000-6-3, EN 61000-6-4, EN 50491-5-1, EN 50491-5-2, EN 50491-5-3
	Low-Voltage Directive 2014/35/EU	EN 60730-1, EN 60730-2-9, EN 62479
	RoHS Directive 2011/65/EU	EN IEC 63000
	RED Directive 2014/53/EU	EN 300328 (V2.1.1)

Overview of types

Type	Features
EY6AS80F021	Modular BACnet automation station and web server

Accessories

Plug-in I/O modules

Type	Description
EY6IO30F001	modu630-IO 16 × DI/CI inputs I/O module
EY6IO70F001	modu670-IO 8 × DI/CI/DO(OC), 8 × DI/CI I/O module
EY6IO31F001	modu631-IO 8 × UI(DI/CI/AI), 8 × DI/CI I/O module
EY6IO71F001	modu671-IO 8 × AO, 8 × DI/CI I/O module
EY6IO50F001	modu650-IO 6 × relay (2A) outputs I/O module
EY6IO72F001	modu672-IO 4 × AO, 4 × DO(OC), 4 × UI (DI/CI/AI) I/O module (planned for mid-2021)

Connection modules

Type	Description
EY6LC01F001	Module for separate I/O module supply
EY6LC02F001	Coupling kit for I/O modules in cabinet (P100017761 and P100017762)

Spare parts

Type	Description
0929360602	AS bus cover with resistor, 5 pcs.

Function expansions

Type	Description
Y6WS80F008	Activation code for the REST API on modu680-AS
Y6WS80F009	Data point extension activation code for moduWeb Unity on modu680-AS
Y6WS80F031	Network option activation code for modu680-AS
Y6FX02F001	Activation code for MQTT client
Y6FX02F002	Activation code for MQTT client and broker
Y6FX03F001	Activation code for RADIUS Supplicant

Manuals

Document number	Language	Title
D100397589	de	Systembeschreibung SAUTER modulo
D100408512	de	EY-modulo 6 – Best Practice I
D100402674	en	SAUTER modulo system description
D100410201	en	EY-modulo 6 – Best Practice I
D100402676	fr	Description du système SAUTER modulo
D100410203	fr	EY-modulo 6 – Meilleures pratiques I

Description of operation

The modulo 6 system family comprises a series of automation stations and I/O and COM modules for building automation for the BACnet/IP system bus.

The modu680-AS automation station is a modular, freely programmable BACnet Building Controller (B-BC) for the automation of HVAC and room automation applications. The station can also be used for other functions in building automation, e.g. in ventilation systems or for decentralised data preparation for Modbus devices or for the central control of multiple VAV boxes.

The integrated moduWeb Unity web server is particularly suitable for small and medium-sized plants. Furthermore, licence Y6WS80F008 for moduWeb Unity offers a standardised REST API that also makes gateway functionality possible.

The web server supports the following activities and functions:

- Commissioning and operation of the station and its attached modules
- Direct visualisation of the data points
- Forwarding of alarms and notifications
- Creation and administration of time profiles (scheduler)
- Creation and administration of calendars (calendar)
- Creation and administration of records (Trend Logs)

With a function licence (Y6FX02F***), the station can be used with MQTT functionality as a BACnet MQTT gateway for direct integration of MQTT-based IoT devices. With the integrated MQTT functionality, the station, as an IoT gateway, can connect the building automation network (OT: operational technology) with a public network (IT: information technology), a private cloud or a public cloud. Authentication and encryption (TLS) are supported and can be configured.

With the help of the powerful CASE Suite programming environment and the available function libraries, standard building automation tasks can be carried out and complex projects created with the integration of subsystems via IP/network or field buses.

The RS-485 A interface enables the connection of Modbus devices.

ecoLink I/O modules, ASV actuators, ecoUnit room operating units and the EnOcean wireless interface can be connected to the automation station via the RS-485 B interface. The wireless interface can be used to integrate the SAUTER ecoUnit 1 wireless room operating units and other standard EnOcean units.

COM modules can be connected to the station and support integration via the Modbus or M-Bus interfaces of special actuators, sensors, operating devices or subsystems.

The modu680-AS offers two separate IP networks that enable the separation of WAN (IT network, internet) and LAN (OT network, BA network). The Y6FX03F001 function extension⁵⁾ enables identification of the device in an IP network according to 802.1X and RADIUS. The connection variants EAP-TTLS/PAP and EAP-PEAP/MSCHAPv2 are supported.

The station can be preconfigured (IP addresses, DOI, names) via the Bluetooth interface and with the SAUTER app.

The microSD card stores the historical data records that can be created using the moduWeb Unity web server.

Special standards such as IEC 61508, IEC 61511, IEC 61131-1 and IEC 61131-2 were not considered during the development.

**Notice**

BACnet/IP is only supported via LAN connections. Routing between WAN and LAN ports is not supported.

Intended use

This product is only suitable for the purpose intended by the manufacturer, as described in the "Description of operation" section.

All related product regulations must also be adhered to. Changing or converting the product is not admissible.

Improper use

The SAUTER modulo 6 system does not have functional safety and is not fail-safe. MTTF, MTBF and MTTR data is not available.

This product is not suitable:

- for safety functions
- in transportation equipment and storage facilities as per Directive 37/2005
- as a measuring device as per EU Measuring Instruments Directive 2014/32/EU
- in outdoor areas and in rooms with the risk of condensation
- on means of transport, e.g. ships.

Engineering notes

Fitting and power supply

**Notice**

Only qualified electricians are permitted to fit and connect the module. Prevent access by laypersons.

The modu680-AS is mounted in a cabinet using a DIN rail (EN 60715).

You must ensure that it is not installed in the immediate vicinity of power contactors, frequency converters or other EMC interference sources. SAUTER generally recommends installation in a separate DDC cabinet field. During installation, there must also be an external, primary isolating facility. Connection may only be performed when the system is disconnected from the electrical supply. All plant devices are connected via pluggable spring-type terminals. When the power supply is being connected, the protective earth must also be connected to the corresponding terminal (protection class I).

Further recommendations can be found in the document "EY-modulo 6 – Best Practice I".

The communication wiring must be carried out professionally and in accordance with the requirements of standards EN 50174-1, EN 50174-2 and EN 50174-3. Communication and plant device wiring must be separated from current-carrying wiring.

Local requirements regarding installation, usage, access, access rights, accident prevention, safety, dismantling and disposal must be taken into account. Furthermore, installation standards such as EN 50178, EN 50310, EN 50110, EN 50274 and EN 61140 must be complied with.

Bus cover

The modu680-AS is supplied with a bus cover. This must be fitted on the right, free side, either on the automation station or on the last I/O or COM module.

⁵⁾ When using the Y6FX03F001 function extension, the automation station must not be connected to daisy chain and ports K and L must be disabled

**Notice**

The bus cover must always be fitted.

A terminating resistor is installed in the cover to prevent signal reflections and data transmission interference. The cover also protects the spring contacts from short circuits and damage.

Further information on fitting and installation can be found in the fitting instructions for the station.

Alive signal

The alive signal, which monitors the internal processes of the modu680-AS, can be picked up potential-free at terminals 09 and 10. If the system is functioning correctly (power supply, operating system and running watchdog process), the alive output is pulsed at 1 to 5 Hz (adjustable).

The following should be noted:

- Connection: max. 24 VDC, load 10 mA
- No switching against ground (potential-free contacts)
- Solid State Relay (no OC)

As a practical application, the signal cable can be connected directly to a digital input (CI) of a second automation station or to I/O modules, and be monitored via software.

Power supply

The device is suitable for operation at 24 V DC. Operation with EY-PS 021 switched-mode power supply is recommended as it is optimally matched to the modu680-AS. It is necessary to use a double-insulated power supply.

DC operation has the lowest power loss and heat generation. This prolongs the serviceable life and minimises the device's own consumption.

The maximum ampacity of the connection terminals must be complied with; to this end, external fuse protection is essential in all cases. When a current-limiting power supply unit is used, such as EY-PS 021, fuse protection in the 24 V electrical circuit is not necessary. The fuse required for the primary electrical circuit on the power supply unit can be found in the manufacturer's instructions.

For the sizing of a DC power supply, the maximum current consumption of the modu680-AS and all other devices attached to the 24 V supply is added up. The next-largest power supply module is selected; a reserve of at least 15% is to be taken into account.

**Notice**

Some field devices (e.g. AXS continuous thermal actuator) and the remote ecoLink 510, 511, 512* I/O modules require a 24 VAC power supply. The remote ecoLink 514, 515 I/O modules can also be supplied with a 24 V DC power supply. However, this must not be the same supply source as that for the station.

**Recommendation**

To increase EMC immunity to burst interference, a braid breaker (e.g. Würth split ferrite 74271132) can be attached to the supply line.









Earth

The earth connector on the modu680-AS is the protective earth and must always be connected to the earth for safety and EMC reasons.

Earthing is performed exclusively at the earthing terminals of the modu6 devices. Signal ground terminals must not be earthed. MM and conductors of the 24 V power supply units must not be earthed.

LED indicator of the station

The following operating statuses of the automation station are displayed:

Status ⁶⁾	Indicator/display	Description
Continuous green		Normal mode
Flashing green		Identification via CASE Sun
Continuous orange		Startup mode ⁷⁾
Flashing orange		The internal backup battery must be replaced
Continuous red		No CASE Engine plan in the station
Flashing red		Program download or configuration active
Rapidly flashing red		Internal device error
Off→Green→Red		LED test sequence

Programming and parameterisation

The complete user program (Engine Plan) and the different parameterisations (BACnet objects, images for moduWeb Unity, etc.) are created using CASE Suite. Up to 1600 BACnet data points including hardware inputs and outputs can be used.

Every station must be configured for communication in an Ethernet network. All settings such as IP address, subnet mask, gateway and instance number (DOI) are parameterised via CASE Suite. Automatic configuration via DHCP servers is also possible.

To be able to visually identify the modu680-AS in a network, the CASE Sun commissioning tool can be used to put the run/fault LED in flashing mode.

The modu680-AS contains a fast operating program. This reads all inputs, processes the parameterised function modules, updates the outputs and handles the necessary communication with other stations or the management level (PC).

The user program can be loaded from any point in the IP network with CASE Suite. Flashing red LED indicators show that there is an active download. The data is written to a flash memory and is retained even if there is a power failure.

The inputs and outputs can be parameterised by the user program and used freely for control and regulation tasks.

Initialisation

An initialisation of the modu680-AS can be carried out before the download with CASE Suite.

Firmware/update

The modu680-AS is delivered with the latest firmware. If a firmware update is available during commissioning, it can be installed directly via the network with CASE Suite. When an update is active, the LED indicator flashes red.

Notice



Only operate the modu680-AS with the latest firmware. Before commissioning, check the firmware version and carry out an update if necessary.
The version of the installed firmware can be read via CASE Suite.

⁶⁾ LED flashing: 500 ms on, 500 ms off

LED flashing rapidly: 100 ms on, 100 ms off

LED test sequence: 1 second off > 1 second green > 1 second red

⁷⁾ During startup mode, the LED lights up red briefly, then green and then orange again.

moduWeb Unity

The embedded moduWeb Unity web server is available ex works and does not require the standard functions to be activated.

The following standard functions are available:

- Configuration of the automation station (menu item: "System"), e.g. IP addresses, notification services (email, SMS), user administration, licence activation or memory management
- Operation of the local plant
- Access to the BACnet objects
- Alarm lists and alarm notification via email and/or SMS
- Display of historical data
- Image dynamisation (if created with CASE)

With the Y6WS80F031 function extension, moduWeb Unity can be used as an operating platform for several BACnet controllers. The additional BACnet devices and objects can be referenced in CASE Vision. Plant diagrams, structured in a navigation tree, can reference local and external objects that appear in the object lists and whose events are written to the alarm list. The same objects are then accessible via the API.



Notice

When the Y6WS80F031 function extension is activated, only the objects explicitly referenced for moduWeb Unity in the navigation tree with CASE Vision are accessible via the moduWeb Unity user interface or API.

API

As a web server, moduWeb Unity provides an API that is designed according to the OpenAPI specification. The API allows access to BACnet objects and various BACnet-relevant information of the station. A dedicated page in the web server shows all available commands and allows users to test them directly.

The API is activated with the Y6WS80F008 function extension.

Technical data for moduWeb Unity

I/O mix	Standard	Function extension (bold)	
		Y6WS80F009	Y6WS80F031
BACnet objects	500	3200	500/3200
Historical data points (via spontaneous message)	400	400	400
Historical data points (polled)	50	50	50
Memory for project data	60 MB	60 MB	60 MB
Data points per chart	1-6	1-6	1-6
Charts	100	100	100
Images	75	250	75/250
User accounts	25	100	25/100
Registered users	5	25	5/25
Number of stations	1	1	150

 The function extensions can be combined.

Internal clock

A Real Time Clock (RTC) is integrated into the station for the time programmes. The date, time and time zone are set in the station when loading the user parameters.

The BACnet services "DM-TS-B" and "DM-UTC-B" are used to synchronise the time and date automatically if a BACnet time server is specified accordingly (e.g. SAUTER Vision Center). The station itself can also serve as a BACnet time server (DM-ATS-A service). Alternatively, the clock can be synchronised with the NTP service. The setting is made in CASE Engine.

The summer time setting (daylight saving) is activated in the network properties (CASE Engine) of the station by default and includes all the automation stations integrated in the same network. If there is a deviation with regard to the European summer time regulation, the switchover dates can be adapted to local conditions.

Time programmes, calendar

The BACnet functionality allows up to 64 time programmes (scheduler) and up to 32 calendar objects (calendar) to be created in the station.

The integrated web server can be used to display, operate or adjust the time or calendar objects.

Battery

A lithium battery (pluggable button cell) ensures that the Real Time Clock for time programmes (scheduler/calendar) keeps running in the event of a power failure.

The battery voltage is monitored by the station.

The battery may only be replaced when the automation station is disconnected from the power supply. During battery replacement, the current time of the internal clock is lost and must be reset.

Follow the safety instructions and the directions in the fitting instructions for the station. If necessary, contact SAUTER Service to replace the battery.

Technical data for the battery

Type (standard)	CR2032 lithium button cell (UN 3091)
Nominal voltage	3 V
Capacity	210 mAh
Dimensions	20 mm × 3.2 mm

The lithium battery should be replaced after five to ten years. It may only be replaced by trained specialist personnel.

The battery voltage is monitored by the station and can be monitored by a programme using the "BAT_ST" module. If necessary, an alarm notification can be generated. The status is updated approx. every 6 hours.

WARNING!



Risk of explosion if the battery is short-circuited during replacement.

► Only use insulated tools when replacing the battery.

The user data from CASE Engine and modified user data (e.g. modified by BACnet client) is permanently stored in the flash memory and does not require a battery buffer.

However, to prevent data loss it is recommended to secure the user data and any changed user data via a backup (e.g. BACnet DM BR).

Behaviour in case of power failure

During mains interruptions, the station is switched off in the correct manner. When the power returns, the system is switched back on according to priority. The behaviour for switching off and on is defined autonomously by the station.

The following applies to BACnet objects and functions here:

- Every restart can be announced with a restart notification (DM-R-A service).
- The "Notification Class Recipient List" is maintained and the clients still automatically receive the event and alarm information without logging in again.
- The COV subscriptions on other stations are logged in again automatically.
- Connections between the integrated automation stations are updated (re-subscription). When the power returns, the station checks the consistency of the data and automatically restarts the communication.

Notice



Power failures in the EY-PS021F021 switched-mode power supply on the primary side (230 VAC) that last less than 100 milliseconds are bridged without switching off or other consequences. The system continues to run in normal mode.

If the power supply from a modu601-LC is interrupted, which changes the integrity of the I/O bus, the I/O bus is resynchronised. The modules that can still be reached by the station are out of operation for about 5 seconds, and are then back in operation. This happens in the event of a power failure and when power is restored. After the power returns, all modules should be operational.

When a station is restarted, it is essential for the modu601-LC power supply to be already present.

Extension options

To extend the base station, additional I/O or communication modules can be used. The modules are arranged directly on the right-hand side of the station and are thus connected via the I/O bus spring contacts.

The station automatically detects the modules connected to the I/O bus. The module attribution and the allocation of inputs and outputs must additionally be carried out by the CASE Suite software in the station.

The number of locally pluggable modules is limited to 24. Up to two additional lines can be created using the modu602-LC coupling kit.

A modu601-LC must be used to supply power to more than 12 modules or to supply power to the I/O modules separately from the automation station.

The termination board supplied with the station must be placed on the last module.

Up to five COM modules (modu6** CM) can be used per station. The COM modules must be used at positions 1 to 5.



NOTICE!

Destruction of electronics!

- ▶ Add or remove I/O modules only when the station is disconnected from the power supply.
- ▶ The current load of max. 1300 mA for the station must not be exceeded. This must be ensured in advance during the engineering.

The maximum current loading is the sum of all the connected devices including the I/O modules and operating units.

The information on the current consumption of the individual I/O modules and operating and indicating units can be found on the respective product data sheets.





RS-485 A interface

The interface can be configured to integrate devices and subsystems that support the Modbus/RTU / ASCII protocols.

The maximum bus length depends on the cable type used and the correct termination with terminating resistors. In general, a 4-wire shielded cable with twisted wire pairs must be used. Observe the correct polarity of all signals. The cable shield of the entire bus line must be connected at all points. On the station side, the cable shield must be connected to the protective earth on one side and as directly as possible. The cable length between the protective earth terminal and the cable shield must not exceed 8 cm in order to achieve optimum interference immunity.

In the case of RS-485 interfaces, the bus wiring must follow line topology. Star, tree or branch topologies are not recommended. The maximum cable length depends on the configured baud rate. The interface has internal terminating, pull-up and pull-down resistors. As with the modu6** CM field bus modules, these must be defined in the project using CASE Engine.

LED indicator of RS-485 A interface

Status ⁸⁾	Indicator/dis- play	Description
Continuous green		OK, normal operation (no bus communication, no plan, empty plan (without Modbus data points), all data points OK)
Flashing green		Network traffic (active bus communication, all data points OK)
Continuous orange		Start-up mode, communication is being set up
Flashing red		Communication error (at least one data point cannot set up correct communication with a Modbus device)
Continuous red		Not used

RS-485 B interface

The interface is used to connect the following devices:

- I/O modules of the ecoLink family
- Room operating units of the ecoUnit 3 series

⁸⁾ LED flashing: 500 ms on, 500 ms off

- ASV actuators
- EnOcean wireless interface
- FCCP 200 operating device

The maximum bus length depends on the cable type used and the correct termination with terminating resistors. In general, a 4-wire shielded cable with twisted wire pairs must be used. Observe the correct polarity of all signals. The cable shield of the entire bus line must be connected at all points. On the station side, the cable shield must be connected to the protective earth on one side and as directly as possible. The cable length between the protective earth terminal and the cable shield must not exceed 8 cm in order to achieve optimum interference immunity.

For Ethernet CAT 5 cables and J-Y(ST)Y cables, the possible bus length is up to 500 m. The bus length is reduced when wireless interface units or EY-RU 3** room operating units are connected (see connection plans). In the case of RS-485 interfaces, the bus wiring must follow line topology. Star, tree or branch topologies are not recommended. The modu680-AS has built-in resistors that are activated/deactivated via software. When they are activated, a terminating resistor at the start of the bus can be omitted.

The RS-485 B interface is equipped with a 24 V output with maximum 1.5 W power for the supply of the connected modules. The 24 V output can be switched on or off with CASE Sun.

Possible combinations of devices on an SLC bus line:

Device	Max.	Combination options					
ASV2*5BF1**	12	12	8	4	8	6	-
EY-RU3** / ecoUnit 3 / ecosCOM	4	-	4	4	-	-	4
FCCP 200	4	-	-	-	-	4	-
ecoLink module	8	-	-	4	4	2	8
Total RS-485 channel	12	12	12	12	12	12	12

 See the data sheet of the individual SLC device for any limitations.

SLC addresses by device and position

Module position in CASE	ASV2**	ecoUnit 3	FCCP 200	ecoLink
1	100	-	-	1
2	101	-	-	2
3	102	-	-	3
4	103	-	-	4
5	104	-	-	5
6	105	-	-	6
7	106	-	-	7
8	107	-	-	8
9	108	1	1	-
10	109	2	2	-
11	110	3	3	-
12	111	4	4	-

Activating terminal and bias resistors (PU/PD) is generally recommended. The terminal resistor is especially important for longer bus lines and/or higher baud rates. If the station is at one end of the bus, the resistor built into the station can be activated with CASE Sun. Activating the built-in PU/PD resistors is particularly recommended if any of the participants are not fail-safe. Both PU/PD resistors can also be activated with CASE Sun.

NOTICE!



Damage to the electronics!

▶ Do not connect older SLC devices that are supplied with 5 V to a 24 V power supply unit.

Start-up behaviour / monitoring function







The communication between the station and the engineered ecoLink modules on the RS-485 B bus is monitored. If the communication fails for longer than the 10 second monitoring time, the affected ecoLink modules switch to the safety status. The data points in the station are marked with the status

“unreliable”. All outputs of the affected ecoLink modules are switched to the defined value for the safety state.

Engineered room operating units are also monitored. The status of the devices is displayed via corresponding “Valid” outputs on the ROOM_UNIT block in CASE Engine.

For details on start-up behaviour and monitoring functions, see the documentation of the respective peripheral devices.

LED indicator of RS-485 B interface

Status ⁹⁾	Indicator/dis- play	Description
Continuous green		OK, normal operation
Flashing green		Network traffic
Continuous orange		Start-up mode, communication is being set up
Flashing red		Communication error (e.g. ecoLink not connected)
Continuous red		24 V supply overloaded
Off		Interface not used, no communication

BACnet mapping

BACnet objects	Description
BI, BO, BV	1-bit binary
AI, AO, AV	32-bit float (analogue)
MI, MO, MV	32-bit unsigned integer (multi-state, 1...8 levels)
PIV	32-bit unsigned integer (positive integer)
PC	32-bit unsigned integer (pulse counter)
LO	32-bit float (lighting output)
TL	TrendLog
EL	EventLog
EE	EventEnrollment
SCHEDULER	Planner
CALENDAR	Calendar
LOOP	Control loop

Meteorological forecast data

The station can obtain weather forecast data (temperature (min., max.), hours of sunshine, global radiation, amount of precipitation, relative humidity, wind speed and direction) for energy-efficient and proactive regulation via a constant internet connection, directly and without additional components.

Local operation (web server, SAUTER app)

The station can display its configuration status on a compatible mobile device with the SAUTER app via the Bluetooth interface. In addition, an IP network-capable device can be logged on to moduWeb Unity via a web browser that supports standard HTML5 and can visualise and operate the configuration and a customer-specific system display.

The plant display can contain the following dynamic objects:

- Alarm lists of the plant
- Setting options for schedules
- Calendar
- Records or historical data
- Preparation of reports with the listed content

Notice



The local operating level of the product is not suitable as an emergency operating level according to Machine Directive 2006/42/EU. Standard EN ISO 13849-1 has not been considered. If applicable, a local emergency operating device must be installed on the plant side.

⁹⁾ LED flashing: 500 ms on, 500 ms off

Access security



NOTICE!

Priority operating units can lose their priority function.

- ▶ Limit the access to the local operating level (including via apps) on site.
- ▶ Consider the access security during the planning and risk assessment of the plant.

Channel and terminal assignment

	Description	Terminal
RS-485 A 4-pin spring-loaded plug-in connector	D-	01
	D+	02
	C (Common)	03
	NC (Not Connected)	04
RS-485 B 4-pin spring-loaded plug-in connector	D-	05
	D+	06
	C (Common)	07
	24 VDC (out)	08
Alive signal 0, 1...5 Hz adjustable (potential-free contact)	A-	09
	A+	10
Power supply	PE	11
	24 V-	12
	24 V+	13



Breach of insulation

Do not connect port C (Common) of the insulated RS-485 A interface to port C (Common) of the non-insulated RS-485 B interface.



Notice

Pay attention to the different supply voltages at the interface for combinations with the modulo 5 predecessor system. For the ecos504/505 room automation station it is only 5 VDC $\pm 5\%$.

Protection mechanisms at application level

The modu680-AS has the following protection mechanisms:

Process manager

Productive processes take precedence over other processes, such as web server communication and REST API and BT interfaces. The control processes of the building automation are always a priority.

Access rights

Access to the web server and the API and BT interfaces is protected by user name and password. The first time a user logs in to the web server, the default password must be changed. The user administration and the setting of the access rights are the responsibility of the system operator. An auto-logout or the duration of a login can be set up.

The physical interfaces (USB, WAN, LAN, SD) can be activated or deactivated by authorised users with CASE Sun or via the web server.

Functional safety

The modulo 6 product series is not suitable for plants or applications that require functional safety (software class A). The modulo 6 products do not have an SIL class and are not fail-safe.

Data security

Together with a Building Data Integrity Manager (e.g. modu615-BM), the integrity of the project data is periodically checked using patented blockchain technology.

Communication security

Internet communication is encrypted where technically possible. The HTTPS and SMTP protocols, for example, are encrypted. When BACnet Secure Connect is being used only encrypted communication is possible.

The system only allows communication via authorised ports. All other ports are blocked by the on-board firewall. In addition, an authorisation list with approved devices can be created.

Firmware update

Only firmware updates signed by SAUTER can be installed.

Disposal

When disposing of the product, observe the currently applicable local laws.

More information on materials can be found in the Declaration on materials and the environment for this product.

Connection diagram

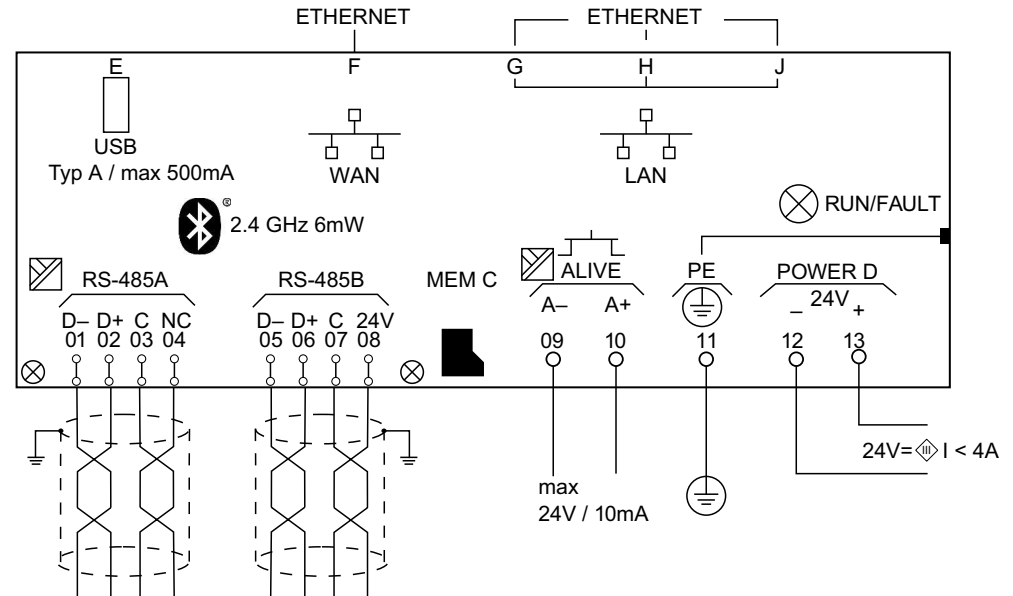

Bus wiring

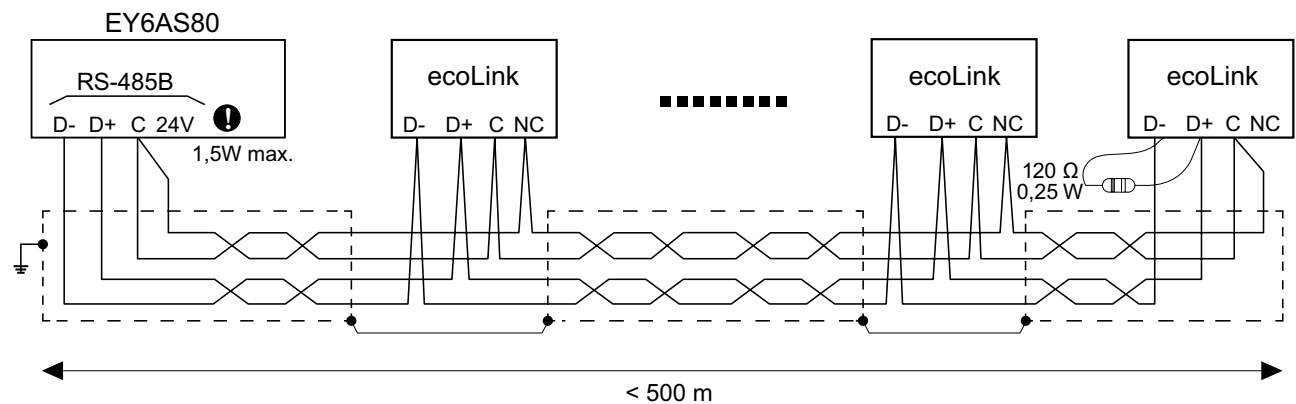
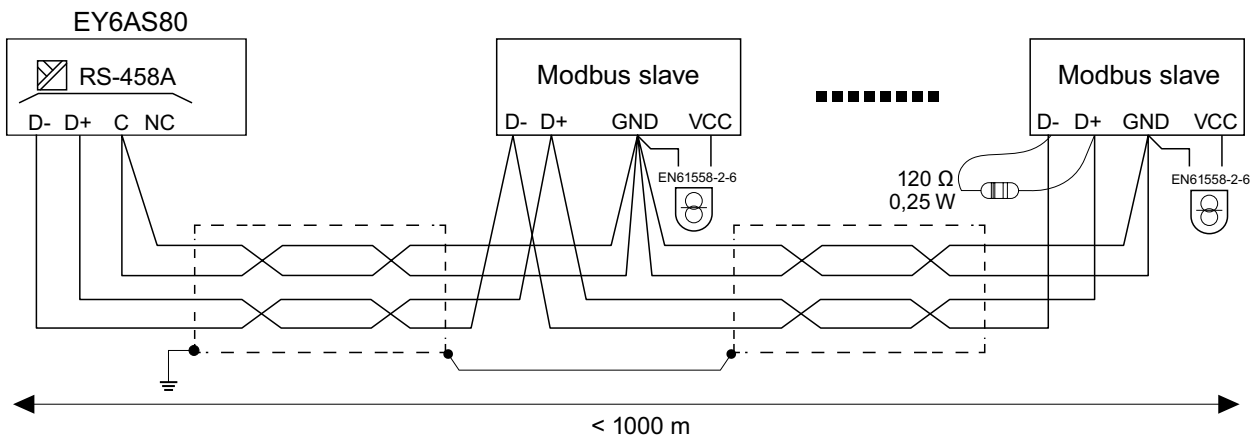

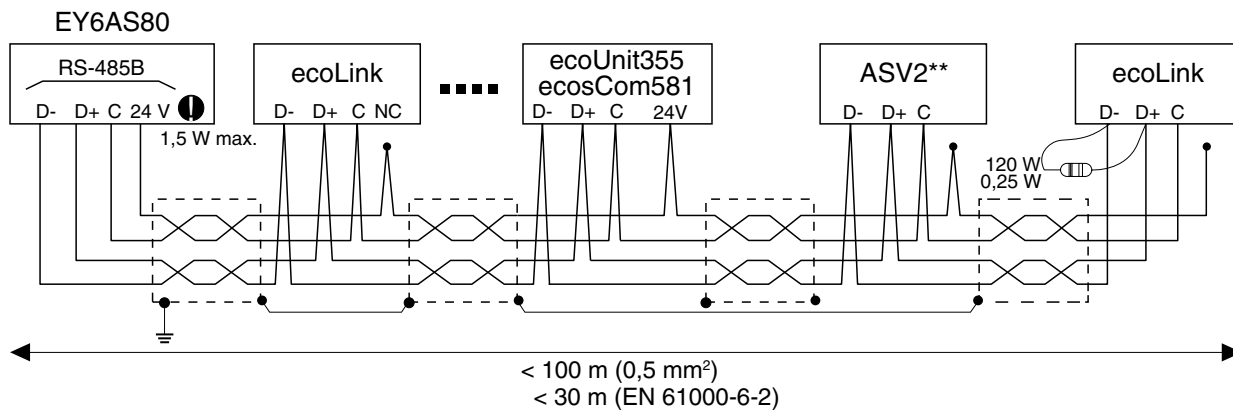

Dimension drawing

All dimensions in mm.

