



SAUTER flexotron800 V2 Ventilation V3.3

manual

P100013557

Content

1	Generell notes	9
1.1	Disclaimer	9
1.2	Trademarks	9
1.3	Safety information	9
1.3.1	Mandatory note	9
1.3.2	General note	10
1.4	Notes for using the manual	10
1.4.1	Markups	10
2	About the manual	11
2.1	Further information	11
3	About flexotron800	13
3.1	News in version 3.3	13
3.2	Application choice	14
3.2.1	Additional menu options	15
3.3	Select language	16
3.4	Ventilation application	16
3.5	flexotron800 hardware overview	19
3.6	flexotron800 model overview	19
3.7	Technical data	20
4	Installation and wiring	23
4.1	Installation	23
4.2	Wiring	24
4.2.1	Supply voltage	24
4.2.2	Inputs and outputs	24
4.2.3	Input and output lists	27
4.3	Wiring diagram RDT828	31
4.4	Wiring diagram RDT828	32
4.5	Wiring diagram RDT815	33
4.6	Wiring diagram RDT815	34
4.7	Wiring diagram RDT808	35
4.8	Empty wiring diagram RDT828	36
4.9	Empty wiring diagram RDT815	37
4.10	Empty wiring diagram RDT808	37
5	Commissioning	39
5.1	General	39
5.2	How to do it	39
5.2.1	Option 1	39
5.2.2	Option 2	40
6	Functional description	43
6.1	Temperature control	43
6.1.1	General	43
6.1.2	Control modes	45

Content

6.1.3	Heater types	48
6.1.4	Heat exchangers	50
6.1.5	Types of chillers	52
6.1.6	Support control	55
6.1.7	Free cooling	56
6.1.8	Cooling recovery	57
6.1.9	Enthalpy control	58
6.1.10	Heat exchanger efficiency monitoring	58
6.1.11	External setpoint	59
6.1.12	Recirculation	59
6.1.13	Change-over	60
6.1.14	Extra temperature sensor	60
6.1.15	Extra flow sensors supply air and extract air	61
6.2	Extra control circuit	61
6.3	Humidity control	61
6.3.1	Humidification	61
6.3.2	Dehumidification	61
6.3.3	Humidification/dehumidification	62
6.3.4	Digital humidity signal	62
6.4	Fan control	62
6.4.1	Pressure control	64
6.4.2	Frequency control flow	65
6.4.3	Frequency control manual	66
6.4.4	Frequency control external control signal	66
6.4.5	Frequency control SAF with EAF slave	66
6.4.6	Frequency control EAF with SAF slave	66
6.4.7	Frequency control SAF with flow control EAF	67
6.4.8	Frequency control EAF with flow control SAF	67
6.4.9	Frequency control SAF and EAF with external flow setpoint	67
6.4.10	Demand controlled ventilation	68
6.5	Pump control	70
6.5.1	Heating circuit	70
6.5.2	Exchanger circuit, liquid connected exchangers	70
6.5.3	Cooling circuit	70
6.6	Damper control	71
6.6.1	Close-off dampers	71
6.6.2	Fire dampers	71
6.7	Extended running and External switch	72
6.8	Time-switch outputs	73
6.9	Alarms	73
6.9.1	Alarm handling	73
6.9.2	Alarm priorities	73
6.9.3	Stop function	73
6.9.4	Alarm text	74
7	Starting and stopping the unit	75
7.1	Start conditions	75
7.1.1	Possibility to block automatic restart at power-up	75
7.2	Stop conditions	75

7.3	Start sequence	76
7.4	Stop sequence	77
8	Display, LEDs and buttons	79
8.1	Display	79
8.2	LEDs	79
8.3	Buttons	79
8.4	Navigating the menus	80
8.4.1	Change parameters	81
9	Access rights	83
9.1	Log on	83
9.2	Log off	84
9.3	Change password	84
9.4	Change password to remove automatic logoff	85
10	Running mode	87
10.1	Running mode, unit	87
10.2	Selected functions	87
10.3	Alarm events	88
10.4	Inputs/Outputs	89
11	Temperature	91
12	Air control	99
12.1	Pressure control SAF and EAF	99
13	Humidity control	105
14	Time settings	107
14.1	Time / Date	107
14.2	Timer Normal speed	108
14.3	Timer Reduced speed	109
14.4	Extended running	109
14.5	Timer outputs 1...5	110
14.6	Holidays	110
15	Manual / Auto	111
16	Settings	115
16.1	Control temp	115
16.2	Control pressure	117
16.3	Control flow	117
16.4	Humidity control	118
16.5	Control Extra unit	118
16.6	Alarm settings	118
16.6.1	Alarm limits	118
16.6.2	Alarm delays	120
16.6.3	Restore alarm	122

Content

16.7	Save and restore settings	122
17	Expansion model	123
17.1	Ports	123
17.2	Wiring	123
17.2.1	Vacon/Lenze/Omron/Emerson/LS/EBM frequency converters	123
17.2.2	Expansion controllers	124
18	Configuration	125
18.1	Inputs and outputs	126
18.1.1	Analogue inputs AI	126
18.1.2	Digital inputs DI	127
18.1.3	Universal inputs UI	127
18.1.4	Analogue outputs	128
18.1.5	Digital outputs	129
18.2	Sensor settings	129
18.3	Control function	129
18.4	Fan control	130
18.4.1	Flow control	130
18.4.2	SAF with EAF slave / EAF with SAF slave	131
18.4.3	SAF with EAF flow control / EAF with SAF flow control	131
18.4.4	Crosswise interlock between fans	132
18.5	Extra control circuit	132
18.6	Extra sequence Y4	132
18.7	Extra sequence Y5	133
18.8	Heating coil	133
18.9	Exchanger	133
18.10	Chiller	134
18.10.1	Min limit lowering	134
18.10.2	Blocking the DX cooling at low outdoor temp	134
18.10.3	Blocking of DX cooling on cooling pump alarm	135
18.10.4	Override of reduced speed for DX cooling	135
18.11	Pump control	135
18.12	Free cooling	136
18.13	Support control	137
18.14	CO2 Demand control	137
18.15	Fire function	137
18.16	Humidity control	138
18.17	Exchanger de-icing	139
18.18	Cooling recovery	139
18.19	Minimum limit dampers	139
18.20	Enthalpy control	139
18.21	External setpoint	140
18.22	Run indication / Motor protection	140
18.22.1	Alarm from frequency converter	141
18.23	Type of actuator	141
18.24	Running time, 3-position actuators	142
18.25	Step controllers	142
18.25.1	Step controller heating	142

18.25.2	Step controller cooling	143
18.25.3	Step controllers Change-over	144
18.26	Recirculation	144
18.27	Pretreatment	145
18.28	Alarm setting	146
18.28.1	Alarm text	147
18.29	Communication	150
18.29.1	Modbus communication	150
18.29.2	Function port 2	152
18.29.3	BACnet communication	152
18.30	Other parameters	152
18.30.1	Start and stop delays for the fans	152
18.30.2	Retardation time	153
18.30.3	Heating at start-up and high speed blocking	153
18.30.4	Start delay exchanger	153
18.30.5	Exchanger to 100% at start and alarm delay at start	154
18.30.6	Split controller signal	154
18.30.7	Outdoor temp. for control mode change	156
18.30.8	Split of optional temp. sequence	156
18.30.9	Fast stop on overheating	156
18.30.10	Automatic restart at power-up	156
18.31	System	157
18.31.1	Change language	157
18.31.2	Choose start display, the text normally shown on the display	157
18.31.3	Automatic summer-/wintertime change-over	158
18.31.4	Address	159
18.31.5	Display anywhere (remote control)	159
18.31.6	Automatic logoff	159
18.31.7	Activation of start-up wizard	160
19	Other functions	161
19.1	Alarm handling	161
19.2	Free text	162
19.3	Revision number	162
19.4	Language	162
19.5	Indication LEDs	162
20	Menu structure	163
21	Changing the battery	167
21.1	Start-up wizard	168
21.2	Energy calculation	170
21.3	SFP (Specific Fan Power)	170
22	Appendix	171
22.1	Frequency converters	171

1 Generell notes

1.1 Disclaimer

The information in this manual has been carefully checked and is believed to be correct. Fr. Sauter AG however, makes no warranties as regards the contents of this manual and users are requested to report errors, discrepancies or ambiguities to Fr. Sauter AG, so that corrections may be made in future editions. The information in this document is subject to change without prior notification.

The software described in this document is supplied under licence and may be used or copied only in accordance with the terms of the licence. No part of this document may be reproduced or transmitted in any form, in any fashion, electronically or mechanically, without the express, written permission of Fr. Sauter AG.

1.2 Trademarks

flexotron is a registered trademarks of Fr. Sauter AG.

Windows, Windows 2000, Windows XP, Windows Vista, Windows 7, Windows 8 and Windows Server 2003 are registered trademarks of Microsoft Corporation.

Some product names mentioned in this document are used for identification purposes only and may be the registered trademarks of their respective companies.

Revision A, August 2014

Software revision: 3.3

1.3 Safety information

1.3.1 Mandatory note

A mandatory note contains important information that you must adhere to. It can contain the following:

- An instruction
- Important information



A mandatory note appears after this symbol. Non-adherence to this note can have serious consequences for the software.

Generell notes

1.3.2 General note

A general note is information to aid understanding and can contain the following:

- Background information
- Information on a specific situation



This can indicate a general note.

1.4 Notes for using the manual

1.4.1 Markups

Format	Use	Action
[SHIFT]	Press button	Press the “Shift” button.
[SHIFT] + [SELECT]	Press button combination simultaneously	Press the “Shift” and “Select” keys at the same time.
[SHIFT] [SELECT]	Press button sequence	First press the “Shift” key, then the “Select” key.
<i>System</i>	Cross-reference, section name	See section <i>System</i>

2 About the manual

This manual covers all the models in the flexotron800 series used with the ventilation application. This revised version contains program functions for software version 3.3.

2.1 Further information

More information about flexotron800 can be found in:

Document name	Description	Language	Document number
SAUTER CASE flexotron800 V2 User Manual	Manual of how to configure the controllers using the PC software SAUTER CASE flexotron	DE, EN, FR	P100012096, P100012097, P100012098
SAUTER flexotron800 V2 User Guide Ventilation application	A simplified manual	DE, EN, FR	P100013559, P100013560, P100013561
List of network variables for Modbus and BACnet communication	Variable list for Modbus and BACnet communication	DE, EN, FR	P100013562, P100013563, P100013564
CE - Declaration of conformity, flexotron800			

The information is available for download from Fr. Sauter AG website, <http://www.sauter-controls.com/de>.

3 About flexotron800

The flexotron800 series comprises three model sizes: 8, 15 or 28 in-/outputs.

In each model flexotron800, all applications are loaded in a separate memory area. A new feature in version 3.3 are models with two and three communication ports. All configuration and normal handling can be done using the display and buttons or using the configuration tool CASE flexotron, installed on a PC and connected via a communication cable.

The controllers are available with or without a front panel display and buttons. For all units, both with and without display and buttons, a separate, cable-connected terminal RDB800 with display and buttons is available.

By connecting one/two expansion units to port two on these units, it is possible to increase the number of inputs and outputs.



The 2- and 3-port flexotron800 models are available only on request. For more detailed information, see chapter 17 *Expansion model*.

3.1 News in version 3.3

- Split of analogue output signal Y1 Heating/Y3 Cooling (change-over).
- Digital output connected to split sequence.
- Extra sequence Y5 added.
- Temperature-dependent air flow compensation has been added. It can be set either to affect normal speed or both normal and reduced speed.
- Air flow compensation depending on controller output, one for heating output and one for cooling output.
- Separate setpoint at reduced speed.
- Runtime indication as digital output.
- Outdoor temperature-dependent room/extract air-compensated setpoints.
- Inverted function on digital out alarm indication.
- Communication with two LS frequency converters.
- Extract air fan (EAF) can now be run during recirculation.
- Energy calculation.
- Port 2 has been updated and can now communicate with a SCADA system via Modbus (earlier, port 2 could only communicate with SAUTER Case flexotron).
- New fan control function. Frequency controlled extract air fan with a supply air fan as slave.
- Possible to change temperature unit from Celsius to Fahrenheit, as well as to set flow unit either to m³/h (cubic meters per hour) or CFM (cubic feet per minute).
- Program date in display (date when software version was manufactured).
- The digital heating output now has a PWM function (Pulse-Width Modulation).
- New analogue input signal, external flow setpoint.
- Configuration of min./max. input signal (volt) for pressure transmitters.
- Modbus communication with EBM fans.
- Frost protection on extra sequence Y4.

About flexotron800

- SFP (Specific Fan Power) – A way to calculate power consumption per flow unit (kW / m3/s).
- Romanian language support.
- Changeable X value (outdoor temperature) for outdoor compensated setpoints in display and web site.
- The order of priority for fire alarms has been changed.
- CO2/VOC control on extra sequence Y4.
- The operating system has been further improved.
- Support for three communication ports.
- BACnet/IP is now available as a communication protocol.
- New filter alarm: Separate filter alarms.
- Analogue filter alarm, filter pressure alarm.
- Temperature alarm for extra sensors 1-5.
- Support for 0...10V outdoor sensor and room sensor.
- Modulating recirculation air damper, Y4-Extra sequence.
- Communication with Danfoss model Frequency converters FC 101 now supported.
- Additional Modbus signals.

3.2 Application choice

On delivery, the main memory of the flexotron800 controller is empty. All the application programs are located in a separate memory area.

On the first start-up, the controller will start a special program for downloading a suitable application and suitable languages to the main memory.

```
RDT828
PLA: 254 ELA: 30
Baud#1: 9600
Rev: 3.3-1-01
```

The initial screen details the model of the flexotron800 unit, its communication address, communication speed and which software revision is loaded into the unit.

Press [down arrow] to go to "Application choices".

```
→ Application
   System
   Communication
   Time/Date
   Input/Output
```

Use the [Up] and [Down] buttons to move the cursor in the left edge of the display to the function you wish to select. Select "Application" and press the [Right] button.

```
flexotron800 Vent.  
flexotron800 Heat.  
Expansion unit 1  
Expansion unit 2
```

Move the cursor to the desired application. Press the [Right] button.

```
Title:  
flexotron800 Ventilation 3.3  
Activate? No
```

Press [OK] and change NO into YES. Press [OK] again.

The most recently loaded ventilation application will now be entered into memory. This will take approx. 30 seconds. The application start screen is displayed.

3.2.1 Additional menu options

System:

Information on the flexotron800 model and serial number:

- MAC address and IP address.
- Battery status and memory size.
- Memory status and voltage frequency.

Communication:

- Communication mode selection.

Serial:

- Enables selecting controller address, communication speed, port mode and routing span.

TCP/IP:

- Choice of DHCP (YES/NO).
- Also enables manual IP address and subnet mask setting before the flexotron800 is initiated. Default Gateway and DNS name is also available under this menu.
- Current subnet mask, gateway and DNS name.
- Main computer status.
- Main computer IP address.
- Permit connection to main computer.
- TCP port routing to serial port 1 or 2.

Time/Date:

- Permits setting the time and date.

Input/Output:

- Enables In-/Output reading and writing

3.3 Select language

To change languages, press the [Right] button 3 times and then choose a language in the same way you selected an application.

```
Choose language
English
```

Press [OK] to choose language. Use the [up] and [down arrows] to move between languages and press [OK] to confirm your choice.

After a few seconds, the display will show a start display in English for the chosen application. After another few seconds, the display text will change to the selected language, if another language than English has been selected.

```
Vent Sys Controller
08:06:03 09:32
System:Stopped
Sp: 19.5 Act: 20.1°C
```

3.4 Ventilation application

The temperature controller is based on a supply air PI-controller for heating control with a pre-programmed set of control modes. A number of different control functions as well as analogue and digital in- and output functions can be bound to this controller. Certain functions are necessary, while others can be considered optional. The choice of which functions are to be used is free, the only restriction is the physical number of inputs and outputs of the different models.

The flexotron800 are designed for DIN-rail mounting.

The program for an air handling unit contains, apart from other things, the following functions:

Different temperature control modes:

- Supply air temperature control, with or without outdoor temperature compensation
- Room temperature control (cascade control).

- Extract air control (cascade control).
- Seasonal switching between supply air temperature control and room/extract air temperature control.
- Outdoor compensated room/extract air control.
- Extra, separate temperature control circuit for after-heaters, etc.
- Extra control sequences Y4 and Y5 (in addition to Y1, Y2 and Y3) for free integration into the controller output.

With control of:

- Heat exchanger (liquid connected- , plate- or rotating) or mixing dampers.
- Heating coil; Water with or without frost protection or electric with high temperature limit switch.
- Cooling: Water or DX cooling in up to 3 steps.
- Circulation pumps heating, cooling, exchanger.

Fan control:

- 1- or 2-speed supply air fans and extract air fans.
- Frequency controlled supply and extract air fans with pressure or flow control, manual control or external control from a VAV system.
- Pressure controlled supply air fan with slave connected extract air fan (output dependent or flow dependent) or opposite function (pressure controlled extract air fan with slave connected supply air fan, output dependent or flow dependent).

Humidity control:

- It is possible to use either humidification or dehumidification, or to use combined humidification and dehumidification.

Timer control:

- For starting and stopping the unit, annual clock function. Up to 5 timer outputs for control of external functions such as lighting, doorlocks etc.

Demand controlled ventilation:

- In buildings with strongly varying occupancy the fan speeds or mixing dampers can be controlled by the air quality measured by a CO2/VOC sensor.

Support control:

- When using the control function room control or extract air temperature control, it is possible to utilise support-heating and/or support-cooling.

Free cooling:

- When this function has been activated, it is used during the summer to cool the building during the night using cool outdoor air thereby reducing the need to run chillers during the day.

Free heating

- If the outdoor temperature is higher than the indoor temperature and there is a heating demand, the recovery damper will not open for recovery but instead open fully for outdoor air. This may occur during low night-time outdoor temperatures, when the room has been cooled considerably and the outside heat is rising faster than indoors. This function is activated at the same time as “Free cooling”.

Enthalpy control

- Measures and compares the energy content (enthalpy) of the outdoor air and the extract air (temperature and air humidity). When this function is active, the mixing damper signal will be overridden to recirculation if the enthalpy is higher outdoors than indoors.

Pretreatment

- Damper and pump control for preheating or precooling of the outdoor air via an underground intake channel.

Enthalpy control for free cooling/heating:

- This function is used to override the mixing damper to increasing recirculation depending on the result of the enthalpy calculation.

Cooling recovery

- If the extract air is colder than the outdoor air and cooling is required, the heat exchanger control is reversed in order to return the cool extract air.
- Used as a recovery function or during heating with support control during the night. Recirculation control is available as an analogue or a digital function.

Recirculation control

- Recirculation of air using a supply air fan and (optionally) extract air fan and a recirculation damper with or without temperature control.

Step controllers Heating/Cooling

- As an alternative to the analogue control of “Actuator heating Y1” or “Actuator cooling Y3” step controllers can be used for controlling heating or cooling in steps using digital control.

Change-over

- In 2-pipe systems where a combination heater/cooler is operating together with a heat pump, Change-over is a function that enables using the same pipe for both heating and cooling, depending on which is currently required. It uses the output Y1 Heating/Y3 Cooling.

3.5 flexotron800 hardware overview

Model	RDT808F012	RDT808F212	RDT815F012	RDT815F212	RDT815F022	RDT815F222	RDT815F032	RDT815F232	RDT828F012	RDT828F212	RDT828F022	RDT828F222	RDT828F032	RDT828F232
Analogue Inputs	2	2	4	4	4	4	4	4	4	4	4	4	4	4
Digital Inputs	3	3	4	4	4	4	4	4	8	8	8	8	8	8
Universal Inputs*	–	–	–	–	–	–	–	–	4	4	4	4	4	4
Analogue Outputs	1	1	3	3	3	3	3	3	5	5	5	5	5	5
Digital Outputs	2	2	4	4	4	4	4	4	7	7	7	7	7	7
RS485	Yes	Yes	Yes	Yes	No	No	Yes	Yes	Yes	Yes	No	No	Yes	Yes
TCP/IP	No	No	No	No	Yes	Yes	Yes	Yes	No	No	Yes	Yes	Yes	Yes
Display	No	Yes	No	Yes	No	Yes	No	Yes	No	Yes	No	Yes	No	Yes
Ext. display	Op*	Op*	Op*	Op*	Op*	Op*	Op*	Op*	Op*	Op*	Op*	Op*	Op*	Op*
1 port	Yes	Yes	Yes	Yes	Yes	Yes	No	No	Yes	Yes	Yes	Yes	No	No
2 ports	No	No	No	No	No	No	Yes	Yes	No	No	No	No	Yes	Yes

UI=universal inputs (can be configured to function as either analogue input or digital input), Op=Option.

All flexotron800 V2 generation controllers support external displays.

3.6 flexotron800 model overview

Model with display	Model without display	Description
RDT808F212 RDT815F212 RDT828F212	RDT808F012 RDT815F012 RDT828F012	Standard controller with RS485 port
RDT815F222 RDT828F222	RDT815F022 RDT828F022	Controller with TCP/IP port
RDT815F232 RDT828F232	RDT815F032 RDT828F032	Controller with TCP/IP port and RS485 port

About flexotron800

3.7 Technical data

Protection class	IP 20 when installed
Display	4 lines of 20 characters Illumination
LEDs	
Yellow	Adjustable parameter
Red	Alarm indicator
Clock	24-hour system clock with battery backup, automatic summer/winter changeover
Power supply	24 V AC $\pm 15\%$, 50...60 Hz or 21...36 V DC
Power consumption	10 VA, 4 W (DC), TCP-models: 12 VA, 5 W (DC)
Start-up current	28 A (2 ms)
Dimensions	148x123x58 (WxHxD including terminals)
Housing	Euronorm (8.5 modules wide)
Mounting	On DIN rail
Operation	
Environmental conditions according to IEC 721-3-3	Class 3k5
Ambient temperature	0...50 °C
Ambient humidity	max. 95% rh
Mechanical requirements according to IEC721-3-3	Class 3M3
Vibration	IEC60068-2-6, Test FC, sinusoidal vibration
Shock	IEC60068-2-27, Test Ea
Transport	
Ambient conditions according to IEC 721-3-2	Class 2k3
Ambient temperature	-20...70 °C
Ambient humidity	max. 95% rh
Mechanical requirements according to IEC721-3-2	Class 2M2
Vibration	IEC60068-2-6, Test FC, sinusoidal vibration
Shock	IEC60068-2-27, Test Ea
Free fall	IEC60068-2-27, Test Ed
Storage	
Ambient conditions according to IEC 721-3-1	Class 1k3
Ambient temperature	-20...70 °C
Ambient humidity	max. 95% rh
Battery	
Type	Replaceable lithium cell, CR2032
Battery life	More than 5 years
Warning	Low battery warning
Battery backup	Memory and clock
Communication	
Communication options depend on the selected model. Suitable model should be selected for appropriate needs.	
Protocol	Modbus RTU, BACnet/IP
Interface	RS485, TCP/IP

EMC emission and immunity standard

This product conforms to the requirements of the EMC Directive 2004/108/EC through product standards EN 61000-6-1 and EN 61000-6-3.

RoHS

This product conforms to the Directive 2011/65/EU of the European Parliament and of the Council.

Inputs

- Analogue inputs AI Configurable as 0...10 V DC or Ni1000, 12 bit A/D
- Digital inputs DI Potential-free connection
- Universal inputs UI Can be used as either analogue or digital input (see information above)

Outputs

- Analogue outputs AO Configurable as 0...10 V DC; 2...10 V DC; 10...0 V DC or 10...2 V DC
8 bit D/A, short-circuit protected
- Digital outputs DO Mosfet outputs, 24 V AC/DC, constant 2 A.
Not short circuit protected. Max. 8 A total.

Optional

- TCP-models Replaces the RS485 Port 1
- With 2 ports One serial port and a TCP/IP port
- External operating unit, RDB800 Used for all flexotron800

Position of the terminals on flexotron 800

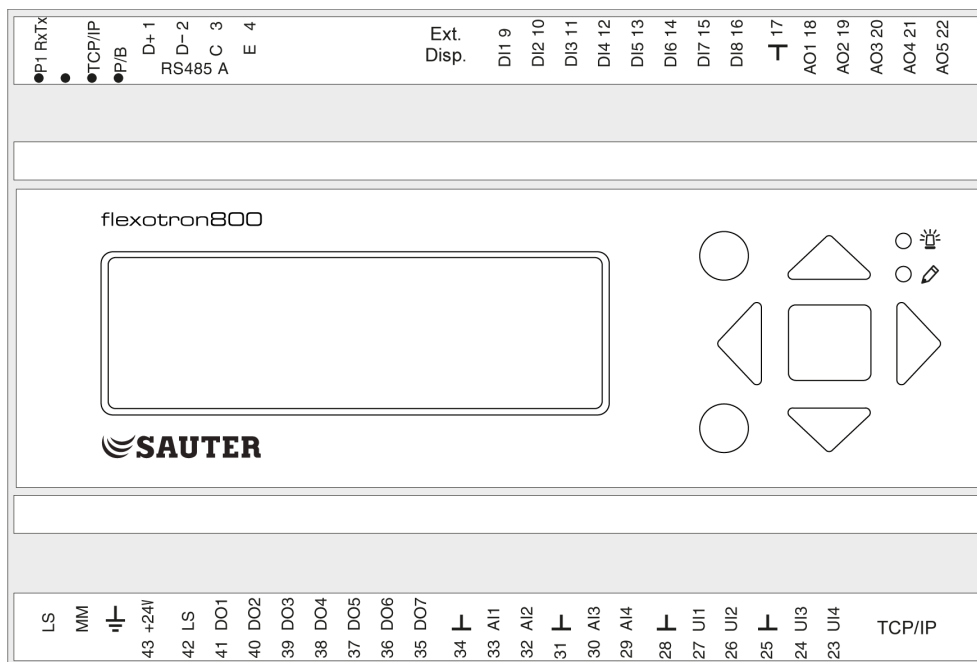

4 Installation and wiring

4.1 Installation

The controller flexotron800 can be mounted in a DIN-standard casing (minimum 9 modules), on a DIN-rail in a cabinet or, using a suitable front-mounting kit, in a cabinet door or other control panel.

Ambient temperature: 0...50 °C.

Humidity: Max. 95% RH, non-condensing.

The picture below shows a wiring example for RDT828:

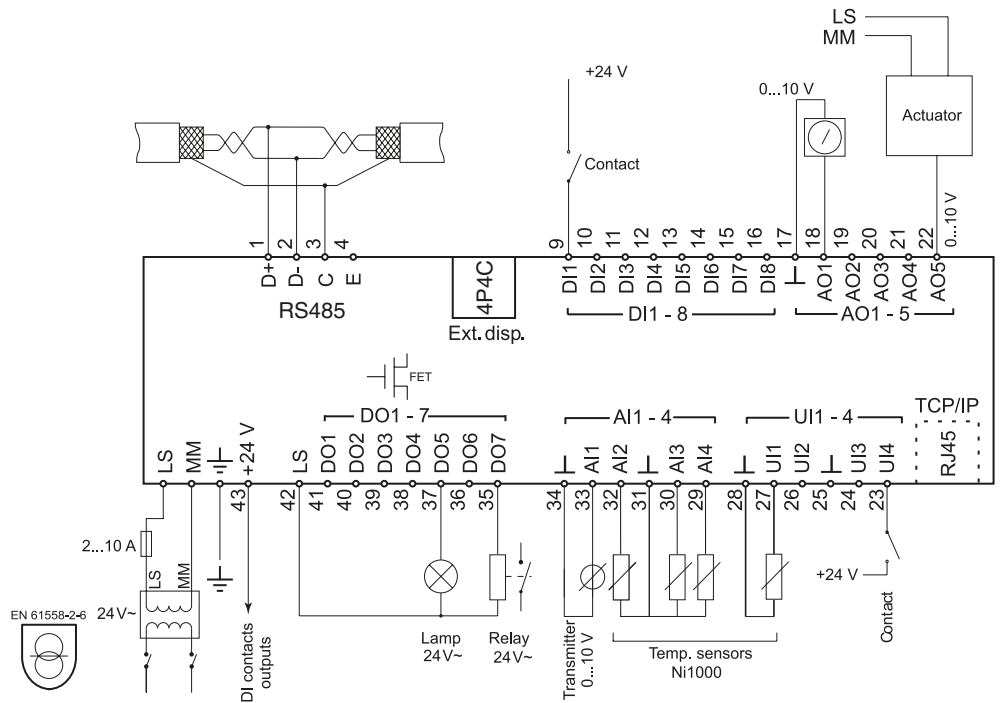

- Options:
- RDT828F022
 - RDT828F032
 - RDT828F222
 - RDT828F232
- Options:
- RJ45
 - TCP/IP

Installation and wiring

4.2 Wiring

At the end of this section are terminal assignment plans that show the available factory setting configurations. There are also empty wiring diagrams. Since the function of most of the inputs and outputs depends on the programming of the unit the final wiring diagram cannot be filled in until the installer has decided how to use the inputs/outputs. It is important to ensure that the wiring is performed correctly and in accordance with the instructions given in this manual.

4.2.1 Supply voltage

24 V~ ±15%, 50...60 Hz or 20...36 V DC



If controller flexotron800 and its connected actuators share the same transformer it is essential that the same transformer-pole is used as reference for all the equipment. The equipment may otherwise not function as intended and may also suffer damages.

4.2.2 Inputs and outputs

The list of input and output lists in section 4.2.3 is a handy instrument to help you keep track of which inputs and outputs you will need to configure.

Analogue inputs

Analogue inputs must refer to an protective earth terminal placed in the same terminal block as the input being wired.

Analogue inputs can, depending on the configuration, be used for either Ni1000 temperature sensors or for 0...10 V DC analogue input signals, for example from a pressure transmitter.

Digital inputs

Digital inputs must refer on terminal +24 V. Digital inputs may only be wired to voltage-free contacts. Any external voltage applied to a digital input may harm the unit. The input signal can be set to either NO or NC.

Universal inputs

A universal input can be configured to act as either an analogue input or as a digital input.

A universal input configured as an analogue input can, depending on the configuration, be used for either Ni1000 temperature sensors or for 0...10 V DC analogue input signals, for example from a pressure transmitter.

Universal inputs configured as an analogue input must refer to an protective earth terminal placed in the same terminal block as the input being wired.

A universal input configured as a digital input must, just like other digital inputs refer to terminal +24 V. It may only be wired to voltage-free contacts.

Analogue outputs

Analogue outputs must refer to the Masse- terminal placed in the AO terminal block.

All analogue outputs can be individually set to any one of the following signals:

- 0...10 V DC
- 2...10 V DC
- 10...0 V DC
- 10...2 V DC

- ❗ If the controller flexotron800 and the actuators connected to it share the same transformer it is essential that the same transformer-pole is used as reference for all the equipment. Failure to do so will prevent the equipment from functioning as intended and may also lead to damages.

Digital outputs

Digital outputs should normally refer on terminal 42 LS. Terminal 42 LS is internally connected on terminal LS and supplies 24 V~ or 24 V= depending on the choice of supply voltage.

All the digital outputs are controlled by MOSFET transistors. The outputs are internally connected with LS and can deliver max 2 A per output. However, the total power for all the DOs must not be over 8 A.

A number of different wiring alternatives are possible depending on the type of supply voltage to the controller flexotron800 and the relay type.

24 V~ supply and 24 V~ relays

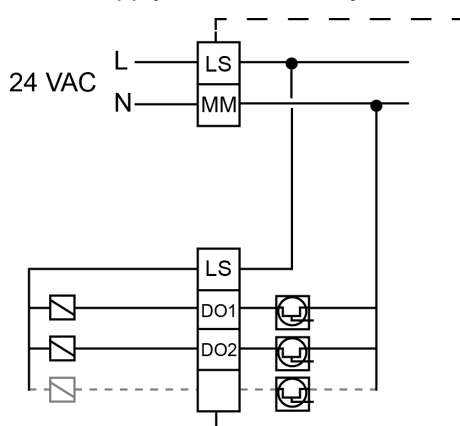

Installation and wiring

24 V= supply and 24 V= relays

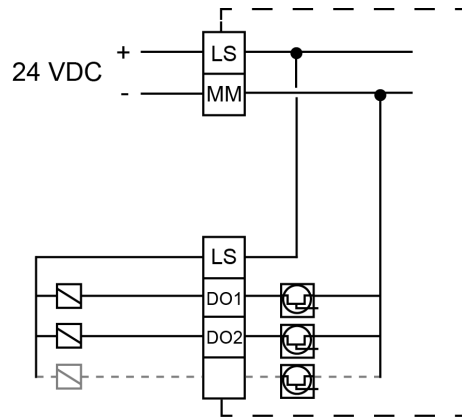

24 V~ supply and 24 V= relays

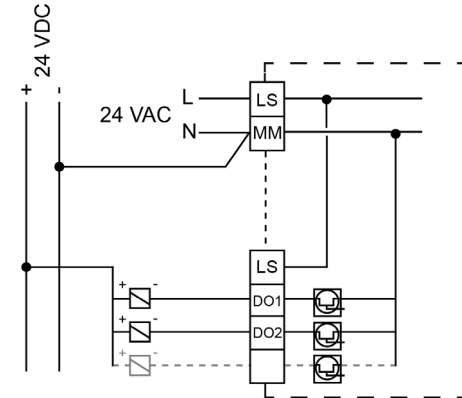

24 V= supply and 24 V~ relays

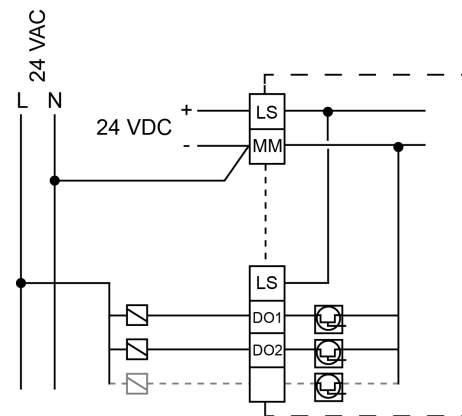

4.2.3 Input and output lists

The lists below are intended to be used during commissioning to help you keep track of the desired input and output functions.

The left column contains a description of the in-/output signal, the middle column displays the name of the corresponding signal in CASE flexotron and the right column shows the text displayed in the flexotron800 controller.

Analogue input signal

✓ Description	CASE flexotron	Display
Inactive input	Not used	Not used
Outdoor temperature sensor Ni1000 or 0...10 V	Outdoor Temp	Outd temp
Supply air temperature sensor	Supply Air Temp	Supplytemp
Extract air temperature sensor	Extract Air Temp	Extracttemp
Exhaust air temperature sensor	Exhaust Air Temp	Exhausttemp
Room temperature sensor 1 Ni1000 or 0...10 V	Room Temp 1	Room temp1
Room temperature sensor 2	Room Temp 2	Room temp2
CO2 sensor, 0...10 V DC	CO2 Sensor	CO2
Pressure transmitter supply air, 0...10 V DC	SAF Pressure	SAF pressure
Pressure transmitter extract air, 0...10 V DC	EAF Pressure	EAF pressure
De-icing sensor, heat exchanger	Deicing Temp	Deicingtemp
Frost protection sensor	Frost Protection Temp	Frost prot. temp
Room humidity sensor	Humidity Room	Humidity room
Duct humidity sensor	Humidity Duct	Humidity duct
Outdoor humidity sensor	Humidity Outdoor	Humidity out
Temperature sensor, Extra controller	Extra unit temp	Extra unit temp
External control supply air fan	External control SAF	SAF ext. Ctrl
External control extract air fan	External control EAF	EAF ext. Ctrl
Pressure transmitter supply air 2	SAF Pressure 2	SAF pressure 2
Intake temperature	Intake Temp	Intaketemp
Extra temperature sensor 1	Extra Sensor Temp 1	Extrasensor1
Extra temperature sensor 2	Extra Sensor Temp 2	Extrasensor2
Extra temperature sensor 3	Extra Sensor Temp 3	Extrasensor3
Extra temperature sensor 4	Extra Sensor Temp 4	Extrasensor4
Extra temperature sensor 5	Extra Sensor Temp 5	Extrasensor5
Extra pressure transmitter supply air	Extra SAF Pressure	Extra SAF Pressure

Installation and wiring

✓ Description	CASE flexotron	Display
Extra pressure transmitter extract air	Extra EAF Pressure	Extra EAF Pressure
External flow pressure transmitter	External flow setpoint	Ext sp flow
Analogue filter guard 1	Filter Guard 1	Filter guard1
Analogue filter guard 2	Filter Guard 2	Filter guard2

Digital input signal

✓ Description	CASE flexotron	Display
Inactive input	Not used	Not used
Filter guard, supply air	Filter guard1	Filter guard1
Filter guard, extract air	Filter guard2	Filter guard2
Run-indication/alarm circulation pump, Heating	Heat Pump Indication	P1-Heating
Run-indication/alarm circulation pump, exchanger	Exchange Pump Indication	P1-Exchanger
Run-indication/alarm circulation pump, Cooling	Cooling Pump Indication	P1-Cooling
Fire alarm	Fire Alarm	Fire alarm
Fire damper end-switch monitoring	Fire Damper Indication	Fire damper-ind
Extended operation, Normal	Extended Operation, Normal	Ext run 1/1
Extended operation, Reduced	Extended Operation, Reduced	Ext run 1/2
External switch	External Switch	External switch
External alarm	External Alarm	External alarm
Flow switch	Flow Switch	Flow guard
Rotation guard exchanger	Exchange Rotation	Rot.sent.exch
Run-indication/alarm supply air fan	SAF Indication	SAF-Ind
Run-indication/alarm extract air fan	EAF Indication	EAF-Ind
Deicing thermostat exchanger	Deicing	De-icing
Frost protection thermostat water heater	Frost Protection	Frost prot
High temperature limit switch	Overheated Electric heater	Overheatprotection
Recirculation start	Recirculation	Recirculation
Change over	Change over	Change over

The universal inputs on RDT828 can be individually, configured as either analogue inputs using any of the analogue input signals above or as digital inputs using any of the digital inputs above.

Analogue output signal

✓ Description	CASE flexotron	Display
Inactive output	Not used	Not used
Y1 Actuator Heating	Heating Y1	Y1-Heating
Y2 Actuator Exchanger	Exchanger Y2	Y2-Exchanger
Y3 Actuator Cooling	Cooling Y3	Y3-Cooling
Frequency converter, supply air fan	SAF	SAF
Frequency converter, extract air fan	EAF	EAF
Actuator Humidity control	Humidity/DeHumidity	Y6-Humidity
Split of any one of temp outputs Y1, Y2, Y3 or Y1 Heating/Y3 Cooling outputs	Split	Sequence
Extra controller	Extra unit control	ExtraUnitCtrlVa
Y1 Heating / Y3 Cooling, Change-over output	Y1 Heating/Y3 Cooling	Y1-Heat/Y3-Cool
Y4 Extra Sequence Also used for control of recirculation air damper 0...10 V	Extra Sequence Y4	Y4-extra sequence
Y5 Extra Sequence	Extra Sequence Y5	Y5-extra sequence

Digital output signal

✓ Description	CASE flexotron	Display
Inactive output	Not used	Not used
Start/stop Supply air fan Normal	SAF Start 1/1 Normal Speed	SAF 1/1-speed
Start/stop Extract air fan Normal	EAF Start 1/1 Normal Speed	EAF 1/1-speed
Start/stop Supply air fan Reduced	SAF Start 1/2 Reduced Speed	SAF 1/2-speed
Start/stop Extract air fan Reduced	EAF Start 1/2 Reduced Speed	EAF 1/2-speed
Start/stop circulation pump, heating	Heating Pump Start	P1-Heating
Fire damper	Fire Damper	Fire damper
Sum alarm A- and B-alarm	Sum Alarm	Sum alarm
Sum alarm A-alarm	Sum Alarm A	A-sum alarm
Sum alarm B-alarm	Sum Alarm B	B-sum alarm
Start/stop circulation pump, cooling	Cooling Pump Start	P1-Cooling
Start/stop circulation pump, liquid exchanger	Exchanger Start	P1-Exchanger
Activation-signal SAF frequency converter	SAF Freq Start	SAF-frequence
Activation-signal EAF frequency converter	EAF Freq Start	EAF-frequence
Activate heating	Heating Activate	Heat start
Activate cooling	Cooling Activate	Cool start
Activate exchanger	Exchanger Activate	Exch start







Installation and wiring

✓ Description	CASE flexotron	Display
Exhaust air close-off damper	Exhaust Air Damper	Exhaust air d
Fresh air close-off damper	Outdoor Air Damper	Outd.air damp
Recirculation damper	Recirculation Air Damper	Recirc. damper
Heating 3-position actuator, increase	Heating Increase	Heat-inc
Heating 3-position actuator, decrease	Heating Decrease	Heat-dec
Exchanger 3-position actuator, increase	Exchanger Increase	Exch-inc
Exchanger 3-position actuator, decrease	Exchanger Decrease	Exch-dec
Cooling 3-position actuator, increase	Cooling Increase	Cool-inc
Cooling 3-position actuator, decrease	Cooling Decrease	Cool-dec
Step controller heating, step 1	Heat Step 1	Heat step1
Step controller heating, step 2	Heat Step 2	Heat step2
Step controller heating, step 3	Heat Step 3	Heat step3
Step controller heating, step 4	Heat Step 4	Heat step4
Step controller cooling, step 1	Cool Step 1	Cool step1
Step controller cooling, step 2	Cool Step 2	Cool step2
Step controller cooling, step 3	Cool Step 3	Cool step3
Extra time channel 1	Time Channel 1	Timer 1
Extra time channel 2	Time Channel 2	Timer 2
Extra time channel 3	Time Channel 3	Timer 3
Extra time channel 4	Time Channel 4	Timer 4
Extra time channel 5	Time Channel 5	Timer 5
Humidity	Humidity/DeHumidity	Humidity
External controller active	Extra unit active	ExtraUnitActi
Heating/cooling step 1	Heat/cool step 1	HeatCoolStep1
Heating/cooling step 2	Heat/cool step 2	HeatCoolStep2
Heating/cooling step 3	Heat/cool step 3	HeatCoolStep3
Free cooling operation	Free cool run	Free cool run
Pretreatment	Pretreatment	Pretreatment
Split sequence active	Sequence Activate	Split sequence
Run indication	Run indication	Run ind.
Pulse modulated heating output	Heating PWM	Heating PWM

4.3 Wiring diagram RDT828

(Configuration 828 Cascade & CO2)

(See also picture of terminal positions on page 21)

	LS	Power supply 24 V AC $\pm 15\%$. 50/60 Hz, or 24V DC	1	D+	RS485 Modbus (not with web (TCP/IP) models)
	MM		2	D-	
		Earth conductor	3	C	
43	+24 V	+24 V DC. Reference point for digital inputs DI	4	E	
42	LS	Reference point for digital outputs DO	-	-	
41	DO1	Heating coil pump	-	-	
40	DO2	Supply air fan variable-frequency drive enabled	-	-	
39	DO3	Return air fan variable-frequency drive enabled			
38	DO4	Collective alarm	9	DI1	External OFF switch
37	DO5	Cooling demand	10	DI2	Frost-protection facility
36	DO6	Not used	11	DI3	Supply air fan on
35	DO7	Not used	12	DI4	Anti-icing function
			13	DI5	Heating coil pump on
34		Reference potential for analogue inputs AI	14	DI6	Filter monitor
33	AI1	Outside temperature	15	DI7	Not used
32	AI2	Supply air temperature	16	DI8	Return air fan on
31		Reference potential for analogue inputs AI			
30	AI3	Frost-protection sensor	17		Reference potential for analogue outputs AO
29	AI4	Return air temperature	18	AO1	Y1 actuator for heater
			19	AO2	Y2 actuator for HRec
28		Reference potential for universal inputs UI	20	AO3	Y3 actuator for cooler
27	UI1	CO2 sensor	21	AO4	Supply air fan
26	UI2	Setpoint for room temperature	22	AO5	Return air fan
25		Reference potential for universal inputs UI			
24	UI3	Not used			
23	UI4	Not used			

Installation and wiring

4.4 Wiring diagram RDT828

(Configuration 828 cascade & humidity)



(See also picture of terminal positions on page 21)



	LS	Power supply 24 V AC $\pm 15\%$. 50/60 Hz, or 24 V DC	1	D+	RS485 Modbus (not with web (TCP/IP) models)
	MM		2	D-	
		Earth conductor	3	C	
43	+24 V	+24 V DC. Reference point for digital inputs DI	4	E	

42	LS	Reference point for digital outputs DO	-	-	
41	DO1	Heating coil pump	-	-	
40	DO2	Supply air fan, level 1	-	-	

39	DO3	Supply air fan, level 2	9	DI1	External OFF switch
38	DO4	Collective alarm	10	DI2	Frost-protection facility
37	DO5	Cooling demand	11	DI3	Supply air fan on
36	DO6	Heat demand	12	DI4	Not used
35	DO7	Not used	13	DI5	Heating coil pump on

34		Reference potential for analogue inputs AI	14	DI6	Filter monitor
33	AI1	Outdoor temperature sensor	15	DI7	Not used
32	AI2	Supply air temperature	16	DI8	Return air fan

31		Reference potential for analogue inputs AI	17		Reference potential for analogue outputs AO
30	AI3	Frost-protection sensor	18	AO1	Y1 actuator for heater
29	AI4	Return air temperature	19	AO2	Y2 actuator for HRec

28		Reference potential for universal inputs UI	20	AO3	Y3 actuator for cooler
27	UI1	Room humidity	21	AO4	Not used
26	UI2	Setpoint for room temperature	22	AO5	Humidity
25		Reference potential for universal inputs UI			
24	UI3	Supply air humidity			
23	UI4	Not used			

4.5 Wiring diagram RDT815

(Configuration 815 cascade control)



(See also picture of terminal positions on page 21)

	LS	Power supply 24 V AC $\pm 15\%$. 50/60 Hz
	MM	or 24 V DC
		Earth conductor
43	+24V	+24 V DC. Reference point for digital inputs DI

1	D+	RS485 Modbus (not with web (TCP/IP) models)
2	D-	
3	C	
4	E	

42	LS	Reference point for digital outputs DO
41	DO1	Heating coil pump
40	DO2	Supply air fan, level 1
39	DO3	Supply air fan, level 2
38	DO4	Collective alarm

-	-	
-	-	
-	-	

34		Reference potential for analogue inputs AI
33	AI1	Outdoor temperature sensor
32	AI2	Sensor for supply air temperature
31		Reference potential for analogue inputs AI
30	AI3	Frost-protection sensor
29	AI4	Return air temperature

9	DI1	External OFF switch
10	DI2	Frost-protection facility
11	DI3	Supply air fan on
12	DI4	Anti-icing function

17		Reference potential for analogue outputs AO
18	AO1	Y1 actuator for heater
19	AO2	Y2 actuator for HRec
20	AO3	Y3 actuator for cooler

Installation and wiring

4.6 Wiring diagram RDT815

(Configuration 815 fixed-value)



(See also picture of terminal positions on page 21)

	LS	Power supply 24 V AC $\pm 15\%$. 50/60 Hz or 24 V DC
	MM	
		Earth conductor
43	+24V	+24 V DC. Reference point for digital inputs DI

1	D+	RS485 Modbus (not with web (TCP/IP) models)
2	D-	
3	C	
4	E	

42	LS	Reference point for digital outputs DO
41	DO1	Heating coil pump
40	DO2	Supply air fan, level 1
39	DO3	Supply air fan, level 2
38	DO4	Collective alarm

-	-	
-	-	
-	-	

34		Reference potential for analogue inputs AI
33	AI1	Outdoor temperature sensor
32	AI2	Sensor for supply air temperature
31		Reference potential for analogue inputs AI
30	AI3	Frost-protection sensor
29	AI4	Setpoint for room temperature



9	DI1	External OFF switch
10	DI2	Frost-protection facility
11	DI3	Supply air fan on
12	DI4	Anti-icing function

17		Reference potential for analogue outputs AO
18	AO1	Y1 actuator for heater
19	AO2	Y2 actuator for HRec
20	AO3	Y3 actuator for cooler

4.7 Wiring diagram RDT808

(Configuration 808 fixed-value)

(See also picture of terminal positions on page 21)

	LS	Power supply 24 V AC $\pm 15\%$. 50/60 Hz or 24 V DC	1	D+	RS485 Modbus (not with web (TCP/IP) models)
	MM		2	D-	
		Earth conductor	3	C	
43	+24V	+24 V DC. Reference point for digital inputs DI	4	E	
42	LS	Reference point for digital outputs DO	-	-	
41	DO1	Heating coil pump	-	-	
40	DO2	Supply air fan, level 2	-	-	
34		Reference potential for analogue inputs AI	9	DI1	External OFF switch
33	AI1	Outdoor-temperature sensor	10	DI2	Frost-protection facility
32	AI2	Sensor for supply air temperature	11	DI3	Supply air fan on
17		Reference potential for analogue outputs AO	17		
18	AO1	Actuator for heater Y1	18	AO1	

Installation and wiring



4.8 Empty wiring diagram RDT828

	LS	Power supply 24 V AC or 24 V DC, ±15%. 50/60 Hz
	MM	
		Earth conductor
43	+24 V	+24 V DC. Reference point for digital inputs DI



1	D+	RS485 Modbus (not with web (TCP/IP) models)
2	D-	
3	C	
4	E	

42	LS	
41	DO1	
40	DO2	
39	DO3	
38	DO4	
37	DO5	
36	DO6	
35	DO7	

-	-	
-	-	
-	-	

34		Reference potential for analogue inputs AI
33	AI1	
32	AI2	
31		Reference potential for analogue inputs AI
30	AI3	
29	AI4	

9	DI1	
10	DI2	
11	DI3	
12	DI4	
13	DI5	
14	DI6	
15	DI7	
16	DI8	

28		Reference potential for universal inputs UI
27	UI1	
26	UI2	
25		Reference potential for universal inputs UI
24	UI3	
23	UI4	

17		Reference potential for analogue outputs AO
18	AO1	
19	AO2	
20	AO3	
21	AO4	
22	AO5	



4.9 Empty wiring diagram RDT815

	LS	Power supply 24 V AC or 24 V DC, ±15%. 50/60 Hz
	MM	
		Earth conductor
43	+24V	+24 V DC. Reference point for digital inputs DI

1	D+	RS485 Modbus (not with web (TCP/IP) models)
2	D-	
3	C	
4	E	

42	LS	Reference point for digital outputs DO
41	DO1	
40	DO2	
39	DO3	
38	DO4	

-	-	
-	-	
-	-	

34		Reference potential for analogue inputs AI
33	AI1	
32	AI2	
31		Reference potential for analogue inputs AI
30	AI3	
29	AI4	

9	DI1	
10	DI2	
11	DI3	
12	DI4	

17		Reference potential for analogue outputs AO
18	AO1	
19	AO2	
20	AO3	

4.10 Empty wiring diagram RDT808

	LS	Supply voltage 24 V AC or 24 V DC ±15%. 50/60 Hz
	MM	
		Protective earth
43	+24V	+24 V DC. Reference for digital inputs DI.

1	D+	RS485 Modbus (not in WEB (TCP/IP) models)
2	D-	
3	C	
4	E	

42	LS	Reference for digital outputs DO.
41	DO1	
40	DO2	

-	-	
-	-	
-	-	

34		Reference pole for analogue inputs AI
33	AI1	
32	AI2	

9	DI1	
10	DI2	
11	DI3	

17		Reference pole for analogue outputs AO
18	AO1	

5 Commissioning

5.1 General

Before the controller flexotron800 can be used, all inputs and outputs must first be configured, as well as all relevant parameters.

All commissioning can be done using the flexotron800 front panel display and buttons or using the external display unit RDB800.

CASE flexotron

The best way however, is to configure the regulator by using CASE flexotron

CASE flexotron is a PC-based configuration program specially developed to simplify the commissioning of the flexotron800 series.

When using CASE flexotron the whole configuration and all settings can be done on the computer and then be downloaded to the flexotron800. An infinite number of different configurations can be saved in computer memory for later use.

A communication cable is required in order to configure flexotron800 with CASE flexotron.

The controller flexotron800 must be powered up and the application selected in order for it to be configured.

5.2 How to do it

For configuration using CASE flexotron, see the CASE flexotron manual.

For configuration using the front panel there are two ways to go depending on how much help you need.

5.2.1 Option 1

- Jump straight to section 8 and 9, *Display, LEDs and buttons and Access rights*.
- After learning how to use the buttons and menu system, connect power to your controller, log on as Admin and go to the menu „Configuration“.
- For the time being, skip the configuration menu In-/Outputs and start by configuring control functions.
- Run through the configuration menus in order and set whatever functions and parameters you wish to include. Use section 6 of this manual for reference.
- Keep track of which inputs and outputs you will need. To help you, there is a list of input and output functions provided in section 4, (4.2.3 *Input and output list*.)
- Finally, configure In-/Outputs.
- Exit the „Configuration“ menu and go to „Settings“.
- Set the control values in „Settings“.

Commissioning

- Set the clock and scheduler functions in „Time Settings“.
- Set the control setpoints in temperature and air control as well as in humidity control if humidity control has been configured
- Your controller flexotron800 should now be ready to run.

5.2.2 Option 2

Read this manual in the order given below: The manual has been designed to act as a guide through the commissioning. The last chapters of the manual, not listed below, cover menus and functions that are not used during commissioning.

Functional description

Start by reading chapter 6. Functional description below. Some functions are essential to the working of the unit and must be included. Others are more of the nature of optional extras which can be excluded.

At the end of each function description there is a table of the necessary inputs and outputs to implement the function. At the end of the manual there is a list of all the analogue and digital inputs and outputs. As you read, mark in the list the inputs and outputs you will be using for the application you are building. Note that the universal inputs in RDT828 can, individually, be configured as either analogue or digital inputs.

Display, buttons and LEDs

Read section 8 *Display, LEDs and buttons* on how to use the front panel buttons to navigate the flexotron800 menu system.

Access rights

Read section 9 *Access rights*. Learn how to log on to the flexotron 800.

Configuration

Read section 18 *Configuration*.

Connect power to the controller. Using the buttons and menu system, go through the configuration menus covering the functions you wish to use.

On delivery the units already have the inputs and outputs assigned to various functions. These can, of course, be changed. In chapter 4 Installation and wiring there are two sets of wiring diagrams, one set showing the pre-configured input / output configuration and one set where you can fill your own configuration choices.

Settings

Read section 16 *Settings*

Set the control parameters, P-band, I-time for the temperature control.

Set the control parameters for the pressure control if you have pressure- or flow-controlled fans.

Set the control parameters for the humidity control if activated.

Set the alarm parameters; alarm levels and delay times.

Time settings

Read section 14 *Time settings*.

Set the clock and calendar functions.

Setpoints

Read sections 14 *Time settings*, 16 *Settings*

Set all the setpoints for all active control loops.

Manual/Auto

Read section 15 *Manual / Auto*

Learn to use manual control. Very useful for testing out your system.

Other functions

Read section 19 *Other functions*

Alarm handling etc.

6 Functional description

6.1 Temperature control

6.1.1 General

The controller flexotron800 has a choice of the following control modes:

1. Supply air control
2. Outdoor temperature compensated supply air control
3. Cascaded room temperature control
4. Cascade connected extract air temperature control
5. Outdoor temperature dependent switching between supply air control with outdoor temperature compensation and room temperature control
6. Outdoor temperature dependent switching between supply air control with outdoor temperature compensation and extract air control
7. Outdoor compensated room temperature control
8. Outdoor compensated extract air control

The supply air temperature controller is reverse acting, i. e. the output will increase for decreasing temperature. The controller is a PI-controller with settable P-band and I-time.

In the first mode, the temperature at the supply air sensor will be constantly kept at the user setpoint value. In the second mode, the supply air temperature setpoint is adjusted depending on the outdoor temperature.

In modes three and four the supply air is controlled as part of a cascade controller together with the room/extract temperature controller. The room/extract temperature offset will dictate the supply air temperature setpoint.

Mode five and six vary according to the outdoor temperature: Outdoor temperature compensated supply air control, as in mode two, in winter and cascaded room control or cascaded extract air control in summer, as in modes three or four. The switch-over temperature is settable.

In applications with mixing dampers instead of heat exchanger the signal for the damper control will be reversed compared to the signal for heat exchanger control i. e. decreasing signal on increasing heat demand. This is done automatically on configuring the exchanger output = dampers.

The heater can be either a hot water heater battery or an electric heater.

Outputs

The supply air controller output is split between one or more of the output blocks „Heating Y1“, „Exchanger Y2“ and „Cooling Y3“. Each of these output blocks can be bound to either an analogue 0...10 V DC output or to two digital 3-position increase/decrease outputs.

Each output block has two parameters for setting the control range:

Heating Controller Output signal (HCOOut) at which the output should be 0%

Heating Controller Output signal (HCOOut) at which the output should be 100%

These settings are used to establish the output activation order and to split the P-band between the outputs.

Example:

0% Cooling at HCOOut = 30%

100% Cooling at HCOOut = 0%

0% heat exch. at HCOOut = 32%

100% heat exch. at HCOOut = 50%

0% Heating at HCOOut = 54%

100% Heating at HCOOut = 100%

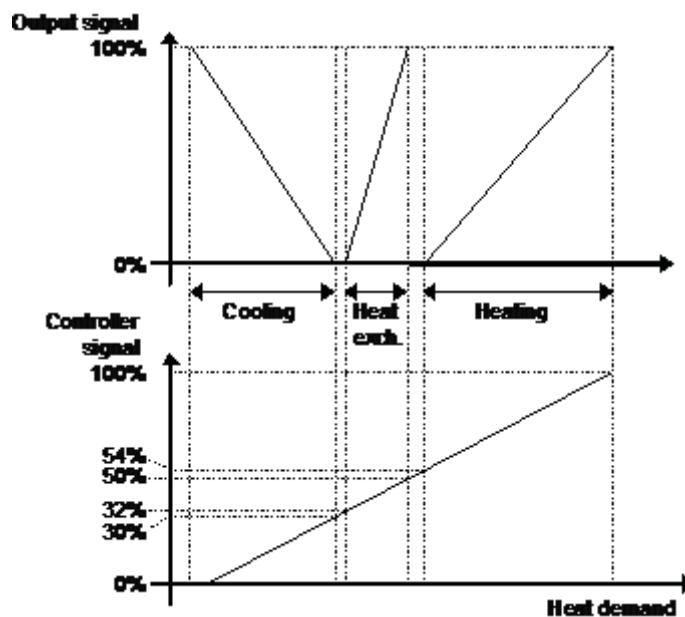

In addition to these three, it is possible to connect two additional analogue output signals for control of optional sequences, Y4 Extra sequence and Y5 Extra sequence. „Y4 Extra sequence“ and „Y5 Extra sequence“ are both set in the same way as above. It is also possible to select whether „Y4 Extra sequence“ should be affected by the enthalpy control and/or the cooling recovery.

A change-over signal can also be configured, „Y1 Heating/Y3 Cooling“.

0% at HCO_{out} = 0% (HCO_{out}=Heating Controller Output)

100% at HCO_{out} = 0% (HCO_{out}=Heating Controller Output)

„Y4 Extra sequence“ can also be used for control of a modulating recirculation air damper. In cases where „Y4 Extra sequence“ controls a water heater battery, frost protection control may be activated.

A change-over signal can also be configured, „Y1 Heating/Y3 Cooling“.

It is also possible to split one of the three analogue outputs Heating, Heat exchanger or Cooling into two equal parts if an additional output function is desired. Y4 Extra sequence, Y5 Extra sequence, Humidity control, Extra controller valve and Y1 Heating/Y3 Cooling can also be split.

There is also a pulse-width modulated digital output, „Heating PWM“. Its period time is settable with a default setting of 60 s.

Example:

With a controller output of 50% and a period time of 60 s, the output will be on for 30 s and off for 30 s. With a controller output of 25% the output will be on for 15 s and off for 45 s.

6.1.2 Control modes

1. Supply air control

The supply air temperature is kept at the setpoint value by controlling the output signals for „Heating Y1“, „Exchanger Y2“, „Cooling Y3“, „Extra sequence Y4“ and „Extra sequence Y5“. A single PI control loop is used.

The setpoint value is set using the front panel or alternatively using an external setpoint device.

Alarms which are activated when the supply air temperature is too high or too low are active.

Alarm for control offset of the supply air temperature is active.

2. Outdoor temperature compensated supply air control

The supply air temperature setpoint is outdoor temperature compensated using a control curve with 8 node points.

The supply air temperature is kept at the setpoint value by controlling the output signals for „Y1 Heating“, „Y2 Heat exchanger“, „Y3 Cooling“, „Extra sequence Y4“ and “Extra sequence Y5”. A single PI control loop is used.

Alarms which are activated when the supply air temperature is too high or too low are active.

Alarm for control offset of the supply air temperature is active.

3. Cascaded room temperature control

Cascade control of room temperature and supply air temperature to achieve a constant, settable room temperature. The room controller output signal generates the supply air controller's setpoint value.

One or two room sensors can be connected. If two sensors are connected the average of their values will be used. The number of room sensors is detected automatically. The room temperature is kept at the setpoint value by controlling the output signals for „Y1 Heating“, „Y2 Heat exchanger“, „Y3 Cooling“, „Extra sequence Y4“ and Extra sequence Y5”. Two PI loops are used.

The room setpoint value is set using the front panel or alternatively using an external setpoint device.

4. Cascaded extract air temperature control

Cascade control of extract air temperature and supply air temperature to achieve a constant, settable room temperature. The extract air controller output signal generates the supply air controller's setpoint value.

The extract air temperature is kept at the setpoint value by controlling the output signals for „Y1 Heating“, „Y2 Heat exchanger“, „Y3 Cooling“, „Extra sequence Y4“ and “Extra sequence Y5”. Two PI loops are used.

The extract air setpoint value is set using the front panel or, alternatively, by using an external setpoint device.

5. Outdoor temperature dependent switching between supply air temperature control and room temperature control

When the outdoor temperature is lower than a settable limit (winter), outdoor compensated supply air temperature control will be active, otherwise (summer) cascaded room temperature control.

6. Outdoor temperature dependent switching between supply air temperature control and extract air temperature control

When the outdoor temperature is lower than a settable limit (winter), outdoor compensated supply air temperature control will be active, otherwise (summer) cascaded room temperature control as in control mode 4.

7. Outdoor compensated room temperature control

The room temperature can be compensated when the outdoor temperature increases. One can, for instance, imagine accepting a slightly higher room temperature if it is warm outside or, conversely, a slightly lower temperature if it is chilly. This function is included to conserve energy.

8. Outdoor compensated extract air control

The extract air temperature can be compensated when the outdoor temperature increases. One can, for instance, imagine accepting a slightly higher extract air temperature if it is warm outside or, conversely, a slightly lower extract air temperature if it is chilly. This function is included to conserve energy.

In- and outputs

1	2	3	4	5	6	7	8	Control mode
AI	AI	AI	AI	AI	AI	AI	AI	Supply air sensor
	AI			AI	AI	AI	AI	Outdoor temperature sensor
		AI		AI		AI		Room sensor
			AI		AI		AI	Extract air sensor
AO	AO	AO	AO	AO	AO	AO	AO	Y1 Heating 0...10 V DC **
AO	AO	AO	AO	AO	AO	AO	AO	Y2 Exchanger 0...10 V DC **
AO	AO	AO	AO	AO	AO	AO	AO	Y3 Cooling 0...10 V DC **
AO	AO	AO	AO	AO	AO	AO	AO	Y4 Extra sequence 0...10 V DC
AO	AO	AO	AO	AO	AO	AO	AO	Extra split Y1, Y2 or Y3 0...10 V DC (optional)
AO	AO	AO	AO	AO	AO	AO	AO	Y1 Heating/Y3 Cooling
DO	DO	DO	DO	DO	DO	DO	DO	Change-over (option)
DO	DO	DO	DO	DO	DO	DO	DO	Heating 3-pos. increase **
DO	DO	DO	DO	DO	DO	DO	DO	Heating 3-pos. decrease **
DO	DO	DO	DO	DO	DO	DO	DO	Exch. 3-pos. increase **
DO	DO	DO	DO	DO	DO	DO	DO	Exch. 3-pos. decrease **
DO	DO	DO	DO	DO	DO	DO	DO	Cooling 3-pos. increase **
DO	DO	DO	DO	DO	DO	DO	DO	Cooling 3-pos. decrease **

**Choose output type depending on the actuator type: Either AO 0...10 V or DO 3-position increase/decrease.

Functional description

6.1.3 Heater types

6.1.3.1 Water heating

Control

When the unit is in running mode the heating valve is controlled by the analogue output "Y1 Heating" or by two digital outputs "Heating 3-pos. actuator, increase" and "Heating, 3-pos. actuator, decrease".

Frost protection

The heater return water temperature is measured using the analogue input "Frost prot.temp". Low temperatures will generate an internal, proportional signal that is used to force the heating valve open thereby preventing freeze-up of the heater.

The internal signal ("Internal signal") will begin to rise as the frost protection temperature falls below "Alarm level" + "Prop. Band" in order to reach 100% output when the signal has fallen to "Alarm level".

When "Internal signal" reaches 100% or the digital input "Deicing Heat exchanger" is activated, the unit is shut down, the heating output is set to completely open mode and an alarm is activated. The unit is restarted when the alarm has been acknowledged and the temperature for the frost protection sensor has risen above "Alarm limit frost" + "P- Band".

Frost protection control is available on Y1 Heating, Y4 Extra sequence or on both Y1 and Y4.

The frost protection alarm level is set in the menu Settings/Alarm settings/Alarm limit.

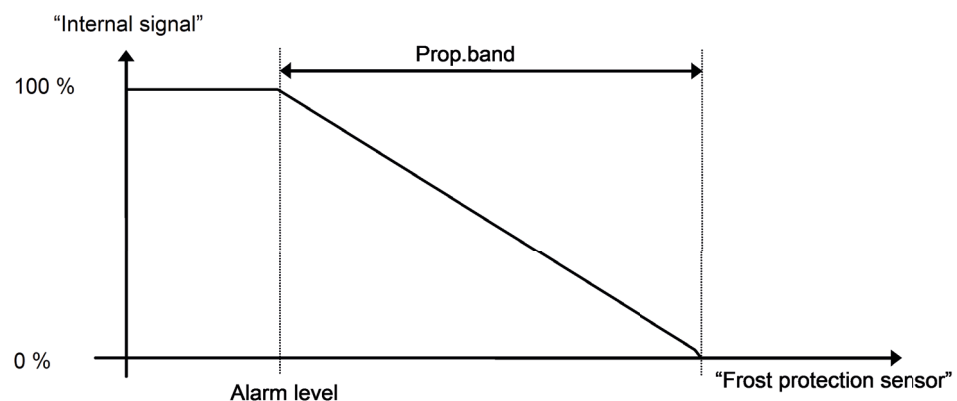

Shutdown mode

If frost protection is activated the controller will go into "Shutdown mode" when the running mode switches to "OFF". The shutdown controller will control the heating output to maintain a constant settable temperature at the frost protection sensor.

6.1.3.2 Electric heating

Control

The heating is controlled using the analogue output "Y1 Heating". On activation of the digital input "High temp limit switch" the unit will be shut down, either according to the stop sequence described in section Start/stop of unit or as an emergency shutdown. The unit will restart after the alarm has been acknowledged and "High temp limit switch" has reset. Note that activation of the input signal "Flow switch" will also stop the unit.

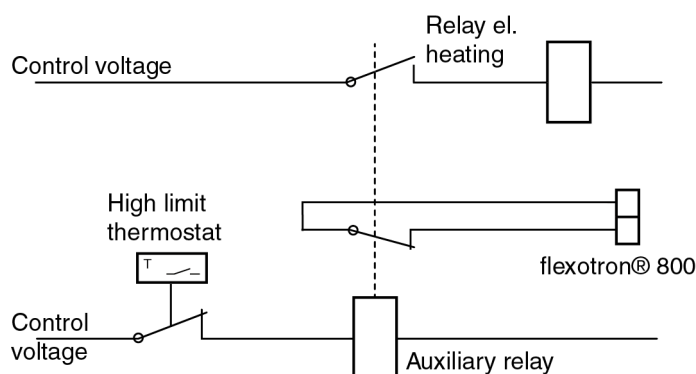

Wiring suggestion high temp limit when using electric heating.
 Contactors drawn **inactivated**.

! It is important that the high temperature thermostat is hardwired to disconnect the power to the heater to ensure that the heating is shut down when the thermostat is activated even if the flexotron800 should be faulty.

6.1.3.3 Water heating and electric heating

The water heating is controlled by „Y1 Heating“, and the electric heating is controlled by the sequence „Split“. Split must always be set to „Heating“ (see section 18.30.8 *Split of optional temp sequence*). On increasing heat demand, the water heating is first activated and then, if needed, the electric heating. Frost protection and overheating protection are both active. If „step controller heating“ is used, the function is tied to the output signal „Split“.

6.1.3.4 Fast stop on overheating

If the function „fast stop on overheating“ is active, the fans will be immediately stopped when there is an overheating alarm, regardless of the set cool-down time.

In- and outputs

Water heating	Electric heating	
AI		Frost protection sensor (optional)
DI**		Frost protection thermostat water heater (optional)
	DI	High temperature limit switch
	DI	Flow switch (optional)

Functional description

**Frost protection can also be created using the digital input "Frost protection thermostat water heater" and an external thermostat. Activation of the input will force the running mode to Off and an alarm will be activated. The heating output is set to completely open, the remaining control outputs are set to zero.

Frost protection thermostat cannot be combined with shutdown mode.

6.1.4 Heat exchangers

The heat exchanger unit can be set to one of the following alternatives:

- Plate exchanger
- Rotating exchanger
- Liquid connected exchanger
- Mixing dampers

6.1.4.1 Plate exchanger

Control

The airflow through the exchanger is controlled by a shut-off damper and a by-pass damper. Both dampers are controlled by the same analogue output "Y2 Heat exchanger" or by two digital outputs "Exchanger 3-pos. actuator, increase" and "Exchanger, 3-pos. actuator, decrease", and are wired so that one opens as the other closes.

De-icing

De-icing is activated either when the digital input signal "De-icing exchanger" is activated or when the value of the analogue input "Deicingtemp" falls below the de-icing limit (-3 °C). It is deactivated when the digital input is reset or the analogue input rises above the limit value plus a settable differential.

On de-icing:

A PI-controller compares the de-icing setpoint with the signal "De-icing Exchanger". The lesser of the output signal from this controller and the output from the ordinary controller is used as output to the dampers.

6.1.4.2 Rotating exchanger

Control

Rotational speed is controlled by the analogue signal "Y2 Heat exchanger" or by two digital outputs "Exchanger 3-pos. actuator, increase" and "Exchanger, 3-pos. actuator, decrease". A rotation sentinel can be connected to the digital input "Rotation sentinel Exchanger". An alarm is generated if this input is activated at the same time as the analogue output signal is higher than 1.0 V.

6.1.4.3 Liquid connected exchanger

Control

A mixing valve in the exchanger circulation system is controlled by the analogue signal "Y2 Heat exchanger" or by two digital outputs "Exchanger 3-pos. actuator, increase" and "Exchanger, 3-pos. actuator, decrease".

The circulation pump (digital output „Start/stop circulation pump, liquid exchanger“) is started as soon as the actuator control signal exceeds 0.1 V and is stopped when the valve has been closed for more than 5 minutes.

De-icing

De-icing is activated either when the digital input signal "De-icing exchanger" is activated or when the value of the analogue input "Deicingtemp" falls below the de-icing limit (-3 °C). It is deactivated when the digital input is reset or the analogue input rises above the limit value plus a settable differential.

On de-icing:

A PI-controller compares the de-icing setpoint with the signal "De-icing Exchanger". The lesser of the output signal from this controller and the output from the ordinary controller is used as output to the actuator.

Outdoor temp control of exchanger

Instead of using Y2 for analogue control of the heat exchanger it can be set to run on-off against outdoor temperature. The function controls a digital output "Exch control", which is activated when the outdoor temperature falls below a set value.

6.1.4.4 Mixing dampers

Control

The analogue output signal "Exchanger Y2", or the two digital output signals „Exchanger 3-position, increase“ and „Exchanger 3-position, decrease“, control two dampers for gradual mixing of outdoor air and recirculated air. In this mode the output signal decreases with increasing heat demand.

CO₂

If demand controlled ventilation (see 6.4.10 *Demand controlled ventilation*) is activated in combination with mixing dampers, and the CO₂-value rises above the setpoint value, the dampers will let in more outdoor air. The function is controlled by a PI-controller. Factory settings: P-band 100ppm and I-time 100 seconds. These values can only be changed in CASE flexotron.

CO₂/VOC control can be used on "Y2 Exchanger" or "Y4 Extra sequence". The control is selectable for use on Y2, Y4 or on both outputs.

Minimum limit

An outdoor air minimum limit for can be set using the front panel. The limit value is settable between 0 and 100%.

Functional description

In- and outputs

Plate	Rotating Exch.	Liquid	Dampers	
AI	AI	AI	AI	Outdoor temp. sensor (optional, outd. temp start)
DO	DO	DO	DO	Activate exchanger (optional, outd. temp start)
AI		AI		De-icing sensor (optional)
DI		DI		De-icing signal (optional)
	DI			Rotation sentinel (optional)

Start delay exchanger

This function delays the exchanger start at start-up of the unit.

100% exchanger output at start-up

After the delay described above, the exchanger output will be 100% during the set time.

6.1.5 Types of chillers
6.1.5.1 Step controller Heating / DX cooling

As alternative or complement to the above mentioned analogue control, heating and cooling can be activated in steps. The internal signal is then used to activate digital outputs for control of the heaters/chillers. Up to four heater outputs and three cooler outputs can be configured. There are two possible modes:

Sequential

Each output step has individually settable on and off values in percent of the control signal. The number of steps is equal to the number of heater/chiller groups. Minimum on and off times can be set, i.e. the minimum time the step has to be inactive or active for a change to occur.

Binary

The heater power outputs should be binary weighted (1:2:4:8 for heating, 1:2:4 for cooling). The number of loads to be controlled is set. Thereafter the program will automatically calculate the individual activation levels. Switching differential and minimum on/off times can be set. The number of heating steps will be: $2^{no. \text{ of groups}} - 1$. In binary mode, the analogue output signal may be used to fill out between the steps. The signal will go 0...100% between the activation of each step. The load connected to the analogue signal should have the same size as the smallest of the binary groups. In the example below there are 4 heater groups (1:1:2:4) and the total number of heating steps is eight.

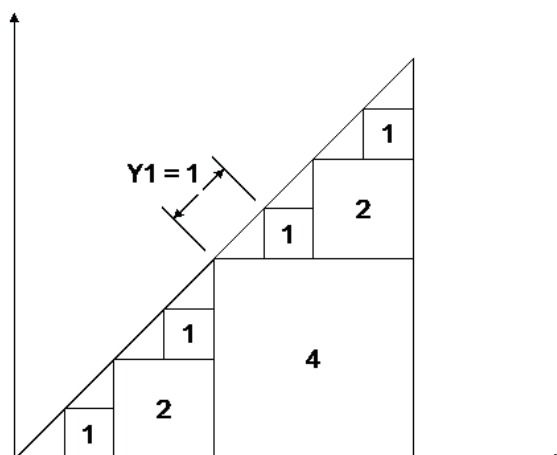

6.1.5.2 Step controllers and Change-over

The digital output signals „Heating/cooling step 1“, „Heating/cooling step 2“ and „Heating/cooling step 3“ are used for step controllers during Change-over control (see section 6.1.13 *Change-over*). They have the same functions as other step controller outputs, but are set to either heating or cooling depending on whether heating or cooling is required.

6.1.5.3 DX cooling with room or extract air control

If DX cooling is used in conjunction with room temperature control or extract air temperature control, there are two configuration alternatives, DX cooling or DX cooling with exchanger control.

DX cooling without exchanger control

When running cascade control, the supply air controller setpoint is normally controlled by the room/extract air controller output signal.

When DX cooling is activated, the supply air controller setpoint is lowered to five degrees (adjustable) below the setpoint given by the room/extract air controller. This prevents the DX cooling from being activated/deactivated too often.

DX cooling with exchanger control

When running cascade control, the supply air controller setpoint is normally controlled by the room/extract air controller output signal.

When DX cooling is activated, the supply air controller setpoint is lowered to five degrees (adjustable) below the setpoint given by the room/extract air controller. This prevents the DX cooling from being activated/deactivated too often. If the supply air temperature falls below the setpoint given by the room/extract air controller, the heat exchanger output will be activated in order to try to maintain the supply air setpoint given by the room/extract air controller. The output uses

Functional description

P-control with a P-band of half the setpoint lowering (adjustable, 2.5 °C as default). The setpoint given by the room/extract air controller cannot drop below the set min limit. When there is no longer a cooling demand, the supply air controller setpoint will return to the value given by the room/extract air controller.

 The function cannot be used if the exchanger signal controls a mixing damper.

Example:

The room controller gives a supply air setpoint of 16 °C. If there is a cooling demand, the supply air controller setpoint is lowered to 11 °C (16 – 5) and DX cooling is activated. Should the supply air temperature fall below 16 °C, the exchanger output will be activated and reach 100% output when the supply air temperature has fallen to 13.5 °C (16 - 2.5).

6.1.5.4 Blocking of DX cooling at low outdoor temperature

DX cooling can be blocked when the outdoor temperature is low. It is possible to block the three cooling steps individually or to block all DX cooling. The temperature limits are adjustable (13 °C default) and have a fixed one degree hysteresis.

When two DX cooling steps are used with binary function, the cooling effect is divided into three steps. The desired blocking level can be set individually for each of these steps.

When three DX cooling steps are used with binary function, the cooling effect is divided into seven steps. However, the controller still only has three blocking level settings. Therefore, Blocking step 1 will apply to binary steps 1 and 2, Blocking step 2 to binary steps 3 and 4, and Blocking step 3 to binary steps 5, 6 and 7.

6.1.5.5 Blocking of DX cooling at low supply air fan speed

When DX cooling is used in conjunction with pressure controlled or flow controlled fans it is possible to block DX cooling if the supply air fan control signal falls below a preset values. For sequential control, the blocking level is individually settable for each DX cooling step.

When two DX cooling steps are used with binary function, the cooling effect is divided into three steps. The desired blocking level can be set individually for each of these steps.

When three DX cooling steps are used with binary function, the cooling effect is divided into seven steps. However, the controller still only has three blocking level settings. Therefore, Blocking step 1 will apply to binary steps 1 and 2, Blocking step 2 to binary steps 3 and 4, and Blocking step 3 to binary steps 5, 6 and 7.

6.1.5.6 Blocking of DX cooling on cooling pump alarm

The controller can be configured to block DX cooling on cooling pump alarm.

In- and outputs

Heating	Cooling	Heating/Cooling Change-over	
DO	DO	DO	Step controller, step 1 (optional)
DO	DO	DO	Step controller, step 2 (optional)
DO	DO	DO	Step controller, step 3 (optional)
DO			Step controller, step 4 (optional)

6.1.5.7 Override of reduced speed for DX cooling

Override to normal quantity of air for DX cooling when the unit runs on reduced quantity of air. The fans can be set to normal operation when cooling is required at high outdoor temperatures (e.g. >14 °C, the same temperature limit as for blocking of DX cooling).

6.1.6 Support control

Support control is normally used when room temperature control or extract air control has been configured. When extract air control is configured a room sensor must be installed. "Support control Heating" or "Support control Cooling" will run if Support control is configured, the running mode is in Off-state (timer control OFF and not in extended running) and if conditions call for support control (see below). Minimum run time is settable 0 to 720 minutes (FS= 20 minutes).

Support control can also be configured when supply air temperature control is used, if a room sensor is installed. The controller uses the configured min. (FS=15 °C) and max. (FS=30 °C) limitation values as support control setpoints. However, in this case the min. and max. limitation values cannot be changed. To change the values, temporarily configure room control, change the min. and max. values and then change back to supply air control.

Support control can also be configured to start only with the supply air fan. In this mode, the extract air fan is not active. This requires a digital output to be configured, which controls the recirculation damper to open completely so the supply air fan can circulate the air to and from the room. The digital output is called "recirculation damper".

6.1.6.1 Support control heating

Demand for support control heating is when the room temperature is lower than the start value which is settable 0 to 30 °C. The fans will run at the preset speed, the heater and the heat exchanger are controlled by the supply air temperature controller with the configured max limitation for the supply air (FS=30 °C) as setpoint and the cooling is shut off (0%). Support control heating stops when the

Functional description

room temperature rises to the stop value and the minimum run time has been exceeded or the running mode changes to "ON".

6.1.6.2 Support control cooling

Demand for support control cooling is when the room temperature is higher than the start value which is settable 20 to 50 °C. The fans will run at the preset speed, the heater and the heat exchanger are shut down (0%) and the cooling is controlled by the supply air temperature controller with the configured minimum limitation (FS=15 °C) as setpoint. Support control cooling stops when the temperature falls below the stop value and the minimum run time has been exceeded or the running mode changes to "ON".

6.1.7 Free cooling

This function is used during the summer to cool the building night-time using cool outdoor air, thereby reducing the need for cooling during the day and saving energy.

Free cooling requires an outdoor sensor (or an inlet temperature sensor) and either a room sensor or an extract air sensor. The outdoor sensor can be placed in the fresh air inlet duct.

Free cooling is only activated when all the start conditions are fulfilled.

Start conditions:

- Less than four days have passed since the unit was last in running mode.
- The outdoor temperature during the previous running period exceeded a set limit (22 °C).
- It is between 00:00 and 07:00:00 in the day (settable).
- The timer outputs for „normal speed“, „Extended running, Normal“ and „External switch“ are OFF.
- A timer channel will be ON sometime during the recently started 24 hours.

If the outdoor sensor is located in the fresh air inlet duct and/or an extract air sensor is selected and ALL the start conditions are fulfilled, free cooling is activated and will run for 3 minutes to ensure that the temperature measurement when using an extract air sensor reflects the corresponding room temperature and that the outdoor temperature sensor senses the outdoor temperature even if it is placed in the fresh air inlet duct. If the outdoor sensor is not located in the fresh air inlet duct and a room sensor is selected, the unit will not start free cooling as long as all the temperatures are not within the start and stop temperature intervals.

After three minutes, the stop conditions will be controlled.

Stop conditions:

- Outdoor temp above the set max. value (18 °C) or below the set min. value (condensation risk, 10 °C).
- The room temp/extract air temp. is below the set stop value (18 °C).
- The timer outputs for „normal speed“, „Extended running, Normal“ or „External switch“ are On.
- It is past 07:00:00 in the day.

If any stop condition is fulfilled after three minutes, the unit will stop again. Otherwise, operation will continue until a stop condition is fulfilled.

When free cooling is active, the fans run at normal speed or the set value for pressure/flow control and the digital output „Free cooling operation“ is active. The outputs „Y1-Heating“, „Y2-Heat exchanger“ and „Y3-Cooling“ are shut down. After free cooling has been active, the heating output is blocked for 60 minutes (configurable time).

In- and outputs

AI	Outdoor temperature sensor or Intake temperature
AI	Room sensor or Extract air sensor
DO	Free cooling operation

6.1.8 Cooling recovery

If the cooling recovery has been configured, there is a cooling requirement and the extract air temperature is a settable amount lower than the outdoor temperature, cooling recovery can be activated. When cooling recovery is activated the heat exchanger signal will be reversed to give increasing recovery on increasing cooling demand. The function also activates the heating function “Free heating”: if heating is required and the outdoor temperature is higher than the extract air temperature, outdoor air will primarily be used.

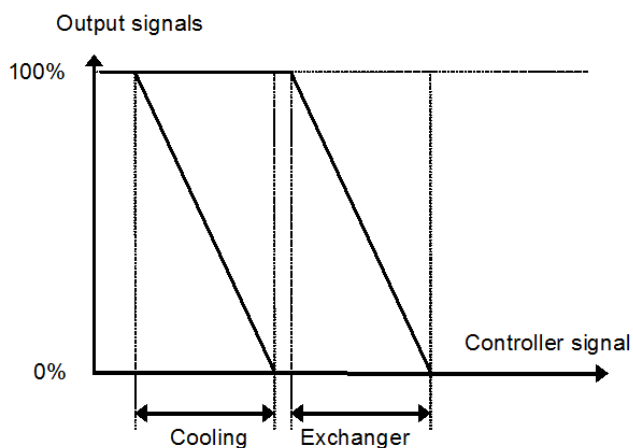

Functional description

In- and outputs

AI	Outdoor temperature sensor
AI	Extract air sensor

6.1.9 Enthalpy control

Calculating the enthalpy means to calculate the energy content of the air, taking into consideration both the temperature and the air humidity. The value is given in energy per kilogram air (kJ/kg). If enthalpy control is configured, the enthalpy is calculated both indoors and outdoors. If the enthalpy is higher outdoors than indoors, the recirculation damper will be overridden to increase the recirculation. The function is not active when using free cooling, in this case outdoor air is used for cooling the room instead. For the enthalpy calculation to be made, four sensors are required:

In- and outputs

AI	Outdoor temperature sensor
AI	Outdoor humidity sensor
AI	Room/Extract air temperature sensor
AI	Room humidity sensor

6.1.10 Heat exchanger efficiency monitoring

General

The function calculates the heat exchanger temperature efficiency in percent when the output signal to the exchanger is higher than 5% and the outdoor temperature is lower than 10 °C.

When the control signal is lower than 5% or the outdoor temperature is higher than 10 °C the display will show 0%.

The heat exchanger efficiency is calculated using the following formula:

$$\text{Efficiency} = \frac{(\text{Extractairtemp} - \text{Exhaustairtemp})}{(\text{Extractairtemp} - \text{Outdoortemp})} * 100$$

Alarm

An alarm is activated if the efficiency falls below the set alarm level (50%).

In- and outputs

AI	Outdoor temperature sensor
AI	Extract air sensor
AI	Exhaust air sensor

6.1.11 External setpoint

An external setpoint device can be connected. The setpoint device must follow the Ni1000 resistance curve, for example the EGT388F002. The unit is connected to the analogue input signal "Extra temperature sensor 1". The function must be activated in the menu "Configuration/External setpoint". The setting range can be min/max limited via a setting in the controller. The factory setting is min: +12, max: +30.

In- and outputs

AI	Extra temperature sensor 1
----	----------------------------

6.1.12 Recirculation

Recirculation is a function for distributing the air in the room using the supply air fan. The function can be used even when there is no heating or cooling demand. When using recirculation control, the extract air fan stops (but can also be set to run) and a recirculation damper opens which allows the air to circulate through the unit.

Recirculation is activated either via a digital input signal or by connecting it to „Timer output 5“. If timer output for normal/reduced speed is activated during recirculation via "Timer output 5", normal/reduced speed gets priority. If timer output for normal/reduced speed is activated during recirculation via a digital input, recirculation gets priority.

Either a digital output (Recirculation damper) or an analogue output (Y4 Extra sequence) can be used as an output signal. When Y4 Extra sequence is used, the damper will become modulating.

Recirculation control can be configured as either air circulation (temperature control inactive) or air circulation with temperature control. (Only heating, only cooling or both heating and cooling). Recirculation control has its own setpoint. However, the other settings are the same as for normal operation, i. e. if normal operation has been configured as room control, room control will also be used during recirculation.

The recirculation setpoint can be configured as constant or offset. Constant means that the recirculation setpoint will be used. Offset is based on an offset from the supply air setpoint.

To lower the temperature, it is possible to configure free cooling to be used during recirculation, if the conditions for free cooling are fulfilled. Then, the recirculation damper closes, the supply and extract air dampers open and the extract air fan starts (the supply air fan also starts, if it is not already running). If the free cooling function is not configured for recirculation control and you want to cool down the supply air via a low recirculation setpoint, the cooling battery will be used. A max. room temperature can be configured for recirculation control. If the room temperature rises above the set value (FS 25 °C), recirculation will be stopped.

Functional description

When the room temperature has fallen 1 K below the set max limit, recirculation will start again if the start conditions are still fulfilled.

When running frequency controlled fans and using recirculation control you can, depending on the type of fan control, configure a special pressure/flow offset for the setpoint or a manual output signal for the supply air fan.

6.1.13 Change-over

Change-over is a function for installations with 2-pipe systems. It makes it possible to use the same pipe for both heating and cooling, depending on whether heating or cooling is required.

A special analogue output signal, „Y1 Heating/Y3 Cooling“, is used for Change-over control. Switching between heating and cooling can be done in two ways. A digital Change-over input signal is normally used. Open contact gives heating control and closed contact gives cooling control. If the input has not been configured, change-over is handled by the internal controller signal. The output signal will follow the two regular output signals „Y1 Heating“ and „Y3 Cooling“. For heating control, the digital outputs "Heating Activate" and "Heat Step 1-4" are active. For cooling control "Cooling Activate" and "Cool Step 1-3" are active.

If frost protection sensor has been configured, it will function in the usual way when heating is active. However, when cooling is active, it will only be used for indicating temperature.

Three digital output signals, „Heat/Cool Step 1“, „Heat/Cool Step 2“ and „Heat/Cool Step 3“, are also connected with change-over. The signals can be used for reversing a step controlled heating pump etc. See also section 18.25.1 *Step controller Heating/ DX cooling*.

The change-over function can be split if needed. If so, set the analogue output to "Split" and select the function Y1 Heating/Y3 Cooling.

A digital function called "Split Sequence" is connected to the split signal. It is active when the corresponding analogue signal exceeds 0.1 V.

6.1.14 Extra temperature sensor

The input signals "Extra Sensor Temp 1", "Extra Sensor Temp 2", "...", "Extra Sensor Temp 5", can be used to add extra temperature sensors for supervision of temperatures that are not related to any control functions. Each sensor has three alarms tied to it: High temperature, Low temperature and Sensor error. "Extra Sensor Temp 1" should be used for external setpoint input.

6.1.15 Extra flow sensors supply air and extract air

The input signals "Extra SAF Pressure" and "Extra EAF Pressure" can be used to display the flow in the supply air and extract air ducts. The K- and X-constants for each fan are used to calculate the flow.

6.2 Extra control circuit

An independent temperature control circuit for control of for example after-heaters. The circuit can be configured to heating or cooling. It has an analogue input signal for temperature sensors and an analogue output signal 0...10 V. There is also a digital output signal which is activated when the analogue output signal is above 1 V and deactivated when the analogue signal is below 0.1 V. The circuit can be configured to be active all the time or to be active only when the main unit is running at normal speed.

6.3 Humidity control

General

Humidity control can be configured as Humidification, Dehumidification or both Humidification and Dehumidification.

Two humidity sensors can be connected, a room sensor for control and an optional duct sensor for maximum limiting. The limit sensor can be omitted.

The humidity control is handled by a PI-controller.

The humidity sensors must give 0...10 V DC for 0...100% RH.

6.3.1 Humidification

An analogue output is used to control a humidifier. The output will increase on decreasing humidity. A digital output can also be used to start a humidifier.

Maximum limitation function using duct humidity sensor:

If the maximum limitation is 80% RH and the hysteresis is 20% RH, the controller output signal will begin decreasing at 60% RH. When halfway to 80% RH (i.e. when at 70% RH), half the output signal will be damped. If the humidity in the duct still reaches 80% RH, the entire output signal will be damped.

6.3.2 Dehumidification

An analogue output is used to control a dehumidifier. The output will increase on increasing humidity. A digital output can also be used to start a dehumidifier.

Functional description

6.3.3 Humidification/dehumidification

An analogue output is used to control a humidifier. The output will increase on decreasing humidity.

The cooling output Y3 will be activated for dehumidification through condensation. The output will increase on increasing humidity. This signal overrides the cooling signal from the temperature controller so the output can be activated for dehumidification even if the temperature controller demand is zero.

For good temperature control when using cooling for dehumidification it is important that the cooler is placed first in the air stream so that the exchanger and heater can be used to reheat the air after dehumidification.

6.3.4 Digital humidity signal

A digital output signal, „Dehumidification/Humidification“, can be used for on/off control of humidifiers/dehumidifiers. The output signal has an activation value and a deactivation value which are connected to the humidity controller output. The signal is activated when the humidity controller output rises above the set activation value and is deactivated when the humidity controller output drops below the set deactivation value.

If a start signal is needed for a cooling unit or a magnetic valve for DX dehumidification, the digital output signal “Start P1-Cooling” should be used. In this case, the “pump” stop delay should be set to 0 s.

Inputs and outputs

AI	Room humidity sensor
AI	Duct humidity sensor
DO	Humidity control output 0...10 V DC
DO	Dehumidification/Humidification

6.4 Fan control

General

Fans can be 1-speed, 2-speed or variable speed via a frequency converter.

1-speed fans are controlled using the digital outputs „Start SAF-Normal“ and „Start EAF-Normal“.

2-speed fans are controlled using the digital outputs „Start SAF-Normal“ and „Start EAF-Normal“ as well as „Start SAF-reduced“ and „Start EAF-reduced“ giving normal and reduced speed respectively.

Variable speed control uses an analogue output per fan for controlling a frequency converter. There are two setpoints for each fan, „Normal“ and

„Reduced“. Pressure or air flow control can be used.

Variable speed fans can also be configured to be run with fixed output values.

Compensation curve

When running pressure control, it is also possible to temperature compensate the pressure.

Crosswise interlock

Crosswise interlock of fans can be configured, which e.g. means that if one fan stops, the other fan will also stop.

Timer outputs, interlock at low outdoor temperatures

The fans are normally controlled by the timer channels for normal and reduced speed. At very low outdoor temperatures, „2-speed fans“ or „pressure controlled fans“ can be forced to „reduced speed“. The limit temperature is settable and the function has a differential of 2K.

Normal, reduced speed

Units with 2-speed or pressure control fans are always started at „reduced speed“. After a settable time, the controller switches to „Normal speed“ if normal speed is valid at start-up. When 2-speed fans are switched from „Reduced speed“ to „Normal speed“, „Reduced speed“ is first disengaged. About 2 sec later, „Normal speed“ is activated.

When the controller switches from „Normal speed“ to „Reduced speed“, there is a settable retardation time from disengagement to activation. See the section 18.30.2 *Retardation time*.

The extract air fan and the supply air fan have individual start and stop delays which are normally set so that the extract air fan is started before the supply air fan. If there are not enough digital outputs for individual control, both fans will have to be started using the signal for the supply air fan, and the delay be created using an external time relay.

Functional description

6.4.1 Pressure control**6.4.1.1 Frequency control pressure**

During pressure control, two separate analogue output signals are used for supply and extract air and two separate analogue input signals for supply and extract air for pressure transmitters. The fan speeds are controlled via frequency converters, thereby maintaining constant pressure.

The pressure transmitter inputs are scalable using "Min volt input (Vmin)" and "Max volt input (Vmax)".

A digital activation signal is normally used for each fan („Start SAF frequency converter“ and „Start EAF frequency converter“), for sending a start signal to the frequency converters. The start signal is activated as long as the fan is expected to be running.

For the supply and extract air fans, there are two individually settable setpoint values, one corresponding to normal speed and one corresponding to reduced speed. Changing between the two setpoint values is done using the timer channels for normal and reduced speed or using digital input signals („Extended Operation, Normal“ and „Extended Operation, Reduced“).

Outdoor compensation

When running pressure control, it is also possible to outdoor compensate the pressure setpoint value.

The outdoor compensation is linear and is set using two parameter pairs which give the value of the compensation at two different outdoor temperatures. The compensation can be positive or negative.

The outdoor compensation is set in the menu Actual/Setpoint.

Using CASE flexotron, you can also choose to only outdoor compensate the pressure value of the supply air fan. In that case, the extract air fan is controlled with constant flow, independent of the outdoor temperature.

The compensation can be selected to apply to both normal and reduced speed, or for normal speed only (factory setting = both speeds).

Extra compensation curve

As a complement to the above outdoor compensation, there is a function called "Extra compensation curve" which can be used to set a compensation based on the room, extract air or supply air temperature. The curve has three parameter pairs which correspond to the value of the compensation at three different temperatures.

Controller output-dependent extra compensation curve

The compensation is made using the control curve, one for heating demand and one for cooling demand. It is possible to select whether the compensation (0...100) should increase or decrease the pressure setpoint. The 0...100 compensation follows the current control quantity for the fans, in this case pressure.

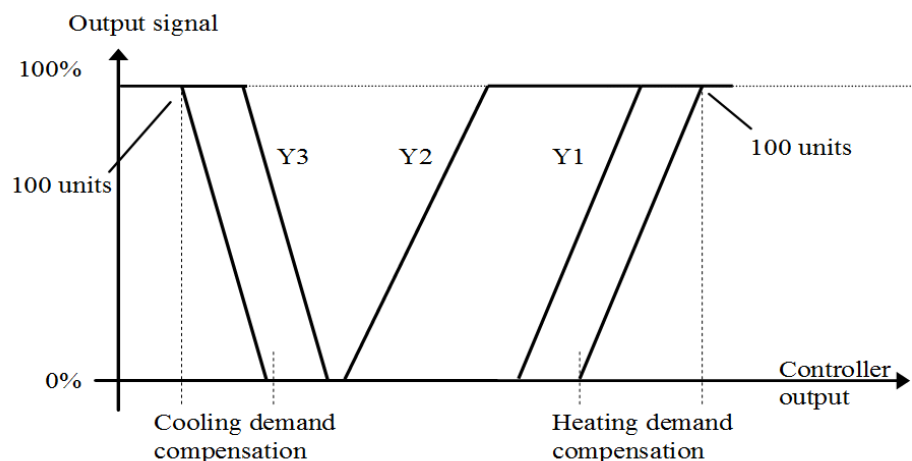

6.4.2 Frequency control flow

Instead of giving a pressure setpoint value, it is possible to use an airflow volume value in m³/h. The value from the pressure transmitter is recalculated to a volume flow using the formula below and the fans will be controlled to give a constant flow.

$$\text{Flow} = K * \Delta P^x$$

Where K and ^x are settable constants dependent on the fan size and ΔP is the differential pressure, measured in Pa, over the fan. Each fan has its own set of parameters.

^x is normally 0.5 indicating that the flow is proportional to the square root of the differential pressure.

Outdoor compensation

Also when running flow control, it is possible to outdoor compensate the setpoint value.

The outdoor compensation is linear and is set using two parameter pairs which give the value of the compensation at two different outdoor temperatures. The compensation can be positive or negative.

The outdoor compensation is set in the menu „Actual/Setpoint“.

Functional description

Using CASE flexotron, you can also choose to only outdoor compensate the flow of the supply air fan. In that case, the extract air fan is controlled using constant flow, independent of the outdoor temperature.

Extra compensation curve

As a complement to the above outdoor compensation, there is a function called "Extra compensation curve" which can be used to set a compensation based on the room, extract air or supply air temperature. The curve has three parameter pairs which correspond to the value of the compensation at three different temperatures.

6.4.3 Frequency control manual

Frequency controlled fans can be controlled at a fixed rotational speed. The rotational speed is selected by setting a fixed output signal (0...100%). Values for normal and reduced speed can be configured for each fan.

Fans that are run with a fixed output signal can also be compensated (see the section above). In this mode, pressure sensors are not needed.

6.4.4 Frequency control external control signal

Two 0...10 V input signals are used for direct control of frequency controlled fans. The signal is received from e.g. a VAV unit. The signal controls the fans 0...100% (0...10 V on the analogue output). Pressure transmitters are not used in this control mode.

6.4.5 Frequency control SAF with EAF slave

The rotational speed of the supply air fan is controlled by a pressure transmitter which is placed in the supply air duct. The extract air fan does not have a pressure transmitter, instead you let the output for the extract air fan follow the control signal for the supply air fan. A scaling factor can be added if the characteristics of the extract air fan are not the same as the characteristics of the supply air fan. (Only pressure control of the supply air fan is possible using this function.) The extract air fan will start directly at 50% after the start delay. Then the heating of the exchanger will work for this operating mode as well. When the supply air fan starts, the extract air fan will be slave controlled by the supply air flow.

6.4.6 Frequency control EAF with SAF slave

The rotational speed of the extract air fan is controlled by a pressure transmitter which is placed in the extract air duct. The supply air fan has no pressure transmitter. Instead, the supply air fan output is made to follow the extract air fan control signal. A scaling factor can be added if the supply air fan characteristics are not the same as the characteristics of the extract air fan (only pressure control of the extract air fan is possible using this function).

6.4.7 Frequency control SAF with flow control EAF

The rotational speed of the supply air fan is controlled by a pressure transmitter which is placed in the supply air duct. The extract air fan is controlled by the supply air flow, in order to achieve a balanced ventilation. A pressure transmitter which is placed in the supply air fan cone („Pressure transmitter SAF 2“) gives a measured value of the present supply air flow. A corresponding pressure transmitter is placed in the extract air fan cone and gives a measured value of the extract air flow.

The supply air flow is the setpoint used for control of the extract air fan. A scaling factor can be added if the extract air fan does not have the same characteristics as the supply air fan.

6.4.8 Frequency control EAF with flow control SAF

The rotational speed of the extract air fan is controlled by a pressure transmitter which is placed in the extract air duct. The supply air fan is controlled by the extract air duct flow in order to achieve a balanced ventilation. A pressure transmitter placed in the extract air fan cone (“Extra SAF Pressure”) provides a measurement of the current extract air flow. A corresponding pressure transmitter is placed in the supply air fan cone, providing a measurement of the supply air flow.

The supply air fan is controlled using the extract air flow as a setpoint. A scaling factor can be added if the supply air fan does not have the same characteristics as the extract air fan.

6.4.9 Frequency control SAF and EAF with external flow setpoint

This signal can be used to control the SAF and EAF flow setpoints from an external VAV system if the “Frequency control external” fan type is used.

If this signal is configured as an analogue input signal, the flow setpoint for the SAF and EAF will be controlled in normal speed.

The signal can be configured by using scaling: Min volt input (Vmin)/Min flow and Max volt input (Vmax)/Max flow.

Minimum limit

For frequency controlled fans an adjustable minimum limit can be set individually on the supply air and extract air fan control signals.

Functional description

In- and outputs

1-speed	2-speed	Pressure/ Flow	
DO	DO		Start SAF Normal
DO	DO		Start EAF Normal
	DO		Start SAF reduced
	DO		Start EAF reduced
		DO	SAF frequency start
		DO	EAF frequency start
DI	DI		Indication/alarm SAF
DI	DI		Indication/alarm EAF
		AI	Pressure transmitter SAF
		AI	Pressure transmitter EAF
		AI	Pressure transmitter 2 SAF
		AI	Extra pressure transmitter SAF
		AI	Extra EAF Pressure
		AI	External flow setpoint
		AO	Frequency converter SAF
		AO	Frequency converter EAF

6.4.10 Demand controlled ventilation

In applications with varying occupancy the fan speeds or mixing dampers can be controlled by the air quality as measured by a CO₂-sensor.

You can choose to activate the function „1. Always“, „2. Only when the running mode is On“, „3. Only when the running mode is Off“.

When the function is activated and combined with pressure controlled fans and the CO₂-value rises above control value one the fans will start at reduced speed, if they are not already running. Should the CO₂-value continue to rise the fan speed will also increase until the CO₂-value reaches control value two at which point the fans will be running at normal speed. The fans will stop when the CO₂-value falls 160 ppm below control value one.

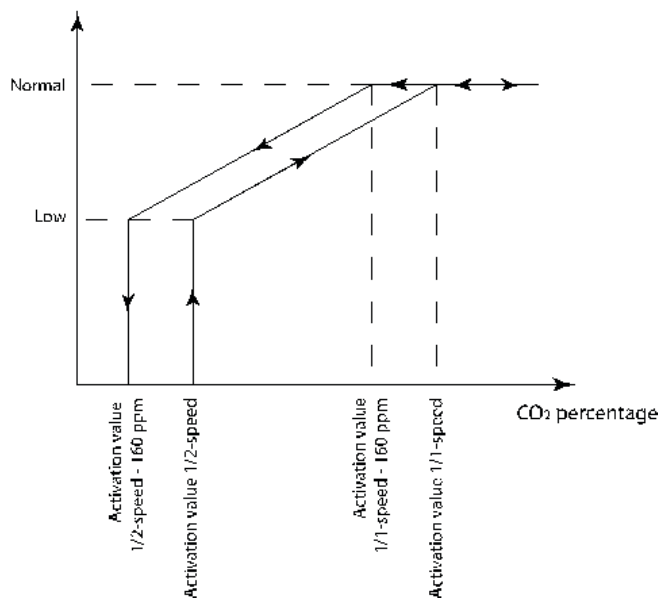

When used with 2-speed fans they will start using reduced speed when the CO₂-value rises above control value one and switch to normal speed when the CO₂-value reaches control value two. The fans will stop when the CO₂-value falls 160 ppm below control value one.

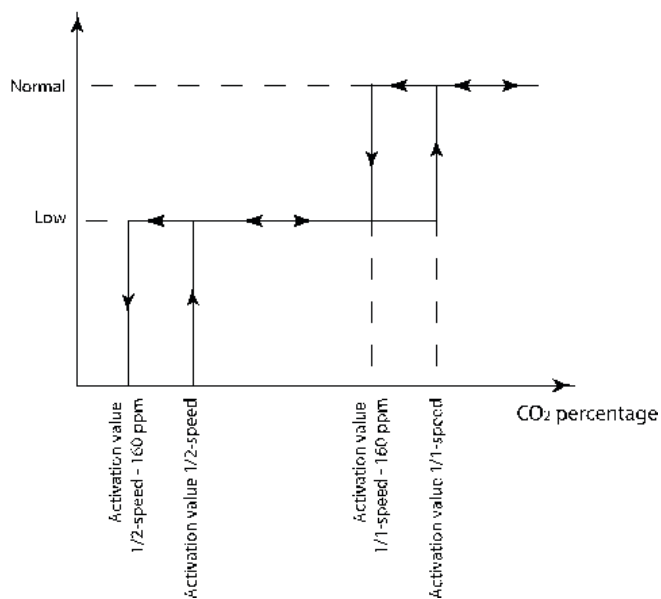

If demand controlled ventilation is activated in combination with mixing dampers, and the CO₂-value rises above the setpoint value, the dampers will let in more outdoor air. The function is controlled by a PI-controller. See section 6.1.4 *Heat exchangers*. The function has a settable minimum running time.

In- and outputs

AI	CO ₂ sensors
----	-------------------------

Functional description

6.5 Pump control

Digital inputs and outputs can be configured for pump control.

All the pumps can use run indication with malfunction alarm or an alarm input connected to a motor protection or similar.

6.5.1 Heating circuit

The circulation pump for the heating circuit will always run when the outdoor temperature is lower than a settable value (FS +10 °C). At higher outdoor temperatures the pump will run when the heating output is larger than 0 V.

If no outdoor temperature sensor has been configured, the stop temperature can be set to 0 °C. Then the pump will only run on heat demand.

The pump has a settable stop delay.

The pump will be exercised once daily at 3 p.m. for one minute or the set shortest running time, whichever is the longest.

6.5.2 Exchanger circuit, liquid connected exchangers

The circulation pump for the exchanger circuit will run when the output to the exchanger valve is larger than 0 V.

The pump has a settable, shortest running time.

The pump will be exercised once daily at 3 p.m. for 1 minute, or the set stop delay, whichever is the longest.

6.5.3 Cooling circuit

The circulation pump for the cooling circuit will run when the output to the cooling valve is larger than 0 V.

The pump has a settable, shortest running time.

The pump will be exercised once daily at 3 p.m. for 1 minute, or the set stop delay, whichever is the longest.

flexotron800 can be configured to block DX cooling if a "Malfunction P1-Cooling" alarm should occur.

In- and outputs

	Heating	Exch	Cooling	
AI				Outdoor temperature sensor
DO	DO	DO	DO	Start/stop circulation pump
DI	DI	DI	DI	Run ind/alarm, circ. pump

6.6 Damper control

6.6.1 Close-off dampers

The outdoor air and exhaust air ducts close-off dampers can be controlled by digital outputs or be hard-wired to the supply air fan relays for normal and reduced speed in such a fashion that the damper is open when the supply air fan is running. When using pressure controlled fans the digital activation signal is activated as soon as the fan has start conditions. This signal can be used to open the close-off damper.

6.6.2 Fire dampers

Fire dampers are normally configured to open on fire alarm. However, they can be configured to be normally open instead via the display.

See section 18.15 *Fire function* for more information on the function.

6.6.2.1 Fire damper exercising

Fire damper exercising can be configured. The exercise interval is settable. To be able to use this function, all the dampers must have end-position switches.

The digital input: „Fire damper end-switch monitoring“ should be wired to all the fire damper end position switches.

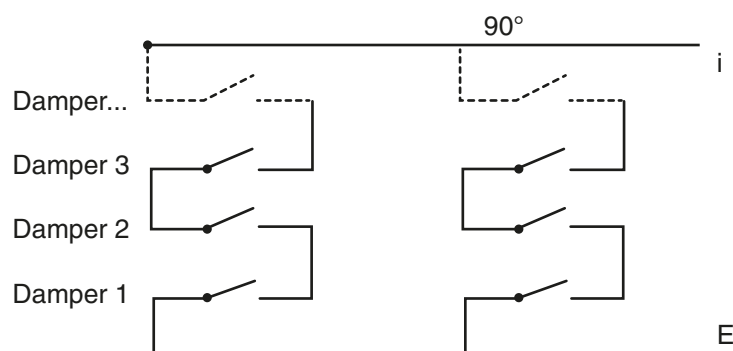

When the test cycle is initiated, the output „Fire dampers“ will be activated and the dampers will begin to move. Within the set time (90 sec) the signal on „Fire damper end-switch monitoring“ must change to indicate that the dampers have left their normal positions. If not an alarm will be triggered.

Then, within the set time, „Fire damper, end-switch monitoring“ must change again to indicate that all the dampers have reached the other end position. If not an alarm will be triggered.

When all dampers have reached the end position the output „Fire dampers“ will be reset to drive the dampers back to normal position. Again, within the set time (90 sec) the signal on the input „Fire damper end-switch monitoring“ must change

Functional description

to indicate that the dampers have left the end positions. If not an alarm will be triggered.

Then, within the set time, „Fire damper end-switch monitoring“ must change again to indicate that all the dampers are back to their normal positions. If not an alarm will be triggered.

The controller can be configured to stop the air handling unit during the damper testing.

All dampers must be wired to the same output in order to get correct results.

The fire alarm input can be configured as normally closed or normally open.

In- and outputs

DO	Outdoor air damper
DO	Exhaust air damper
DO	Fire damper
DI	Fire alarm
DI	Fire damper end switch monitoring

6.7 Extended running and External switch

The digital inputs for extended running can be used to force the unit to start although the timer says the running mode should be “OFF”. Normal running always takes precedence over reduced speed. „Extended Operation. Normal“ takes precedence over the timer output for reduced speed.

For 2-speed fans and pressure/flow controlled fans there are inputs for normal speed and reduced speed. The unit will run for the set time. If the running time is set to 0 the unit will only run as long as the digital input is closed.

The signal “External switch” will stop the unit, even if the timer or one of the signals „Extended Operation. Normal“ or „Extended Operation. Reduced“ says it should stay in running mode.

In- and outputs

DI	Extended Operation, Normal
DI	Extended Operation, Reduced
DI	External switch

6.8 Time-switch outputs

Up to five digital time-switch outputs can be configured. Each timer channel has a separate scheduler with two periods per week-day.

Timer output five can be used to control the function Recirculation. See section 18.26 *Recirculation*.

In- and outputs

DO	Extra time channel 1
DO	Extra time channel 2
DO	Extra time channel 3
DO	Extra time channel 4
DO	Extra time channel 5

6.9 Alarms

6.9.1 Alarm handling

Alarms are indicated by the red alarm-LED or on the front of the external display. All alarms can be monitored, acknowledged and blocked using the display and buttons.

6.9.2 Alarm priorities

Alarms can be given different priority levels, A-alarm, B-alarm, C-alarm or not active. Digital outputs can be bound to act as alarm outputs for A-alarms or B/C-alarms or both A- and B/C-alarms. The digital outputs can be inverted, so that an inoperative alarm gives a high output and vice versa. A- and B-alarms must be acknowledged to reset. C-alarms automatically reset as soon as there is no longer a cause for alarm.

6.9.3 Stop function

For each alarm there is the possibility of choosing whether activated alarm should stop control or not. Automatic restart will take place after removal of the alarm cause and the alarm has been acknowledged.

For some alarm types such as electric heating high temperature limit and water heating frost protection it would be dangerous to not stop the unit on alarm. Therefore, for such alarm types, the program will always reset the stop function to „Active“ even if the operator should choose „Inactive“.

Unfortunately it is not possible to remove the display text concerning the stop function for these alarm types. This since the available program space demands that all alarms are treated in the same way in the display.

Functional description

- 
 For alarms that have been set to „Inactive“, the extra stop function should also be set to „Inactive“, or unexpected malfunctions may occur.

6.9.4 Alarm text

The alarm text that should be shown in the display when there is an alarm can be changed using CASE flexotron. For more information, see the CASE flexotron manual.

In- and outputs

DO	Sum alarm A + B/C
DO	Sum alarm A
DO	Sum alarm B/C

7 Starting and stopping the unit

7.1 Start conditions

The unit will be started and will run when any one of the following conditions is met:

1. Timer output for normal speed or timer output for reduced speed is ON
2. The unit is started manually using the flexotron800 front panel
3. Digital input for extended running is activated
4. Support control is activated and the present room temperature is higher/lower than the preset starting value (Support heating/cooling)
5. Demand controlled ventilation is activated and the value at the CO2 sensor is higher than the preset start condition.
6. Recirculation control has been configured and the conditions for recirculation control are fulfilled.

7.1.1 Possibility to block automatic restart at power-up

The function "Automatic restart at power-up" makes it possible to block automatic restart of the unit at power-up. At power-up, the B-alarm "Restart blocked after power on" is generated. Once this alarm has been acknowledged, the unit will start.

7.2 Stop conditions

The unit will be stopped when any of the following conditions are met:

1. Timer output for normal speed or timer output for reduced speed are OFF, and the signal for extended running is OFF.
2. Activated frost protection alarm. The unit will restart on resetting of the alarm.
3. Activated fire detector if the function has been configured. The unit will restart on resetting of the alarm.
4. If the unit has electric heating and the supply fan flow switch alarm or the high temperature limit alarm is activated.
5. Activation of external switch.
6. The unit is stopped manually using the flexotron800 front panel.

Starting and stopping the unit

7. Support control is activated and the present room temperature is higher/lower than the pre-set stop value (support heating/cooling)
8. Demand controlled ventilation is activated and the value at the CO₂ sensor falls below the pre-set start condition less the set differential.
9. Recirculation control is active and the conditions for recirculation control are no longer fulfilled.
10. At an activated alarm configured with the extra function of stopping the unit on activation. The unit will restart on resetting of the alarm.

7.3 Start sequence

Start of the unit will run according to the following sequence:

1. If the controller is configured for water heating and has an outdoor temperature sensor and the outdoor temperature is below +3°C the heating valve is opened and the heating circulation pump is started.
2. If the controller is configured with a heat exchanger and has an outdoor temperature sensor and the outdoor temperature is below +15°C the heat exchanger will be run at 100% capacity for a pre-set time.
3. Signals for outdoor air and exhaust air dampers are activated.
4. The extract air fan or the pressure control of the extract air fan will be started after a pre-set time.
5. The supply air fan or the control of the supply air pressure will be started after a pre-set time.
6. Thereafter temperature control according to the configured control mode is started. Electric heating, if configured, is not started until a run signal from the supply air fan or flow switch has been received. And not yet activated pumps will be started.
7. After a pre-set delay, the alarm handling system is activated. The unit is in normal running mode.

7.4 Stop sequence

Stopping of the unit will run according to the following sequence:

1. Deactivation of the alarm handling system.
2. Electric heating, if configured, is shut down.
3. After individually set delay times the fans are stopped.
4. Outdoor air and exhaust air dampers are shut down.
5. Actuator signals are set to zero and the pumps are stopped.
6. If shutdown mode is configured, it will be activated.

In order to maintain an acceptable supply air temperature as long as possible, the heat exchanger will continue to run during the stop sequence until everything else is stopped.



8 Display, LEDs and buttons

This section is applicable to controller flexotron800 units with display and buttons but also for external displays RDB800 which can be connected to flexotron800 units without display and buttons.

8.1 Display

The display has four rows of 20 characters and is backlit. The illumination is normally dimmed, but is activated as soon as a button is pressed. The illumination will be dimmed again after a period of inactivity.

8.2 LEDs

There are two LEDs on the front: The alarm LED marked with the  symbol. The "write enable" LED marked with the .

The four LEDs placed next to the upper terminal strip will be described later.

8.3 Buttons

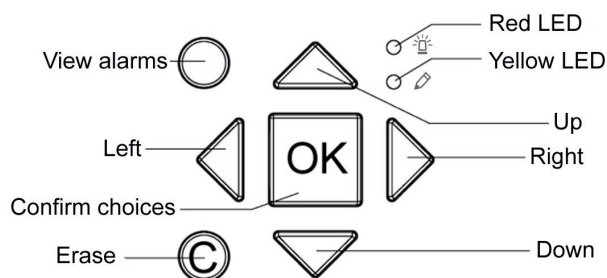

There are seven buttons: four arrow buttons which will be called [Up], [Down], [Right] and [Left]. The menus in the flexotron800 are organized in a horizontal tree structure. The [Up] and [Down] buttons are used to move between menus at the present menu level. The [Right] and [Left] buttons are used to move between menu levels. When changing parameters the [Up] and [Down] buttons are used to increase/decrease the value of the parameter and the [Right] and [Left] buttons to move between digits within the parameter.

- The [OK] button is used to confirm the choice of a parameter setting. See more in the section 8.4.1 *Change parameters* below.
- The [C] button is used to abort an initiated parameter change and restore the original value.
- The [ALARM] button, marked with a red button top, is used to access the alarm list.

8.4 Navigating the menus

The choice of access level/user access determines which menus are shown in the menu system.

The start display, the display normally shown, is at the root of the menu tree.

```
Vent Sys Controller
2013-01-20 13:30
System: Running
Sp: 18.0 Act: 18.2°C
```

Pressing [DOWN] will move you through the menu choices at this, the lowest level. [UP] will move you back through the choices. Which menus are shown depends on which access level you are using (see section 9 *Access rights* for more information about logging on to higher levels).

Using Normal access, the access which normally does not require logging on, only a few basic menus are shown:

```
Running mode
Temperature
Humidity control
Time settings
Access rights
```

In the menu „Running mode“, you can view and set the unit’s running mode, view selected control functions and view the alarm events.

In the menus „Temperature“, „Air control“ and „Humidity control“, you can view actual values and setpoint values. Setpoints can only be changed if you have Operator or Admin access.

In „Time settings“, the time, date and set running times are shown. Values can only be changed if you have Operator or Admin access.

Without logging on to Operator or System level, you are only authorised to change the unit’s running mode and acknowledge alarms.

With Operator access, you can access more information and change other operation parameters like setpoints and time functions.

With Admin access, you have full access to the complete menu system and can change all parameters.

To enter a higher menu level, use [Up] or [Down] to place the display marker opposite the menu you wish to access and press [Right]. At each level there may

be several new menus through which you may move using the [Up] and [Down] buttons.

Sometimes there are further submenus linked to a menu or menu item. This is indicated by an arrow symbol at the right-hand edge of the display. To choose one, use [Right] again. To back down to a lower menu level, use [Left].

8.4.1 Change parameters

In some menus there are parameters that can be set. This is indicated by the yellow LED with  flashing.

A quick blinking (2 times/s) indicates that the parameter can be changed using the present user access. A slower blinking (1 time/s) indicates that a higher user access is required to change the parameter.

To change a parameter, first press the [OK] button. If you need higher authority than you have to change the parameter, a log on menu will be displayed, see section 9 *Access rights* below. Otherwise, a cursor will appear at the first settable value. If you wish to change the value, do so by pressing the [Up] and [Down] buttons.

In numbers containing several digits you can move between the digits using the [Left] and [Right] buttons.

When the desired value is displayed press [OK].

If there are further settable values displayed the cursor will automatically move to the next one.

To pass a value without changing it, press the [Right] button.

To abort a change and return to the initial setting, press and hold the [C] button until the cursor disappears.

9 Access rights

There are four different access levels. The Admin level has the highest access, while the Service, Operator and basic “no-log on” level have the lowest. The choice of access level determines which menus are shown, as well as which parameters can be changed in the displayed menus.

Admin level gives full read/write access to all settings and parameters in all menus.

Service level gives access to all menus except the submenus „Configuration > In- and Outputs“ and „Configuration > System“.

Operator level gives access to all menus except “Configuration”.

The basic level only permits changes in „Running mode“ and gives read-only access to a limited number of menus.

Repeatedly press the [Down] button when the start-up display is shown until the arrow-marker to the left of the text-list points to „Access rights“. Press the [Right] button.

```
Log on
Log off
Change password
```

9.1 Log on

```
Log on
Enter password:****
Actual level:None
```

In this menu it is possible to log on to any access level by entering the appropriate 4-digit code.

The log on menu will also be displayed should you try to gain access to a menu or try to do an operation requiring higher authority than you have.

Press the [OK] button and a cursor marker will appear at the first digit position. Repeatedly press the [UP] button until the correct digit is displayed. Press the [Right] button to move to the next position. Repeat the procedure until all four digits are displayed. Then press [OK] to confirm. After a short while the text on the line: Present level will change to display the new log on level. Press the [Left] button to leave the menu.

Access rights

9.2 Log off

Use this menu to log off from the present level to the basic „no-log on“ level.

```
Log off?
No
Actual level:Admin
```

Automatic logoff

If the access level is Operator, Service or Admin, the user will automatically be logged off to Normal after a settable time of inactivity. See also the section 18.31.6 *Automatic logoff*. It is possible to remove the automatic logoff, see 9.4 below.

9.3 Change password

As default flexotron800 comes with the following passwords for the different levels:

Admin	1111
Service	2222
Operator	3333
Normal	5555

You can only change the password for log on levels lower or equal to the presently active level, i.e. if you are logged in as Admin you can change all passwords, but as Operator you can only change the Operator and Normal passwords. There is no point in changing the Basic password since access to that level is granted automatically to all users

```
Change password for
level:Operator
New password: ****
```

- i** Do not set the password for Admin to the same value as the password for a lower level since this will prevent access to the Admin level.

Forgotten your password? If the password for Admin has been changed and then lost, a temporary password can be obtained from SAUTER. This code is date dependent and only valid for one day.

9.4 Change password to remove automatic logoff

If you want to remove the automatic logoff, change the password of the desired level to 0000. After changing the password, the level will always be activated.

-  This should be done with consideration, since no alarm is continuously given that a certain level has been activated. However, it is very useful in certain cases, if the unit is intended to be used by educated personnel or for instance at commissioning.

10 Running mode

Collected here are a number of menus showing running mode, selected functions, alarm events and status of inputs and outputs.

A complete overview of the menu structure is available in section 20 *Menu structure*.

```
Running mode
Selected functions
Alarm events
Input/Output
```

10.1 Running mode, unit

The unit's running mode can be changed without logging on.

```
Running mode
Auto
```

```
OP time
SAF: 14.6 h
```

10.2 Selected functions

Shows the present configuration. These are read-only menus. No changes can be made here.

```
Control function
Supply air control
Fan control
1-speed.
```

```
Heating: Water
Exchanger: Plate exc
Cooling: Water
```

Running mode

```
Free cool active: No
```

```
Support control
Active: Yes
CO2/VOC active
If time channel on
```

```
Fire damper function
Not active
Operation when alarm
Stopped
```

```
Frost protection
Active
Cooling recovery
No
```

```
External setpoint
Not active
```

10.3 Alarm events

Alarm log which contains the 40 latest alarm events. The most recent event is listed first. The alarm log can only be used for viewing the alarm history. Alarms are handled in a special area, see section 19.1 *Alarm handling*.

```
24 Nov 14:32 B
Malf. SAF

Acknowledged
```

10.4 Inputs/Outputs

This is a read-only menu block showing the present values for all configured inputs and outputs. If correction factors have been applied to input values, the corrected values will be shown.

This is a read-only menu. No changes can be made here.

```
AI
DI
UI
AO
DO
```

Analogue inputs and digital outputs are shown here as examples.

Analogue inputs

```
AI1: 18.5 Outdoortemp
AI2: 20.3 Supplytemp
AI3: 28.2 Extracttemp
AI4: 19.9 Roomtemp1
```

Digital outputs

```
DO1:Off SAF 1/1-speed
DO2:Off EAF 1/1-speed
DO3: On P1-Heating
DO4:Off Sum alarm
```

11 Temperature

Here you can view all actual and setpoint values for temperature control. The menu is visible to all users, regardless of log on level. However, to make changes you need at least Operator authority.

The below menus are available providing the corresponding input has been activated.

Setpoints are available with a separate value for reduced speed. This is achieved using a temperature offset when the unit runs in reduced speed.

The temperature is available in either Celsius (°C) or Fahrenheit (°F).

Setpoint.

Control mode 1: Supply air control.

```

Outdoor temp.: 18.4°C
Supply air temp
Act.: 19.8°C Setp→
Setp.: 20.0°C

```

Submenu: Setpoint

```

Supply air temp
Setp.: 20.0°C

```

Control mode 2: Outdoor compensated supply air control, Control mode 5: Outdoor temperature dependent supply air or room temperature control, Control mode 6: Outdoor temperature dependent supply air or extract air control.

```

Outdoor temp.: 18.4°C
Supply air temp
Act.: 19.8°C Setp→
Setp.: 20.0°C

```

Submenu: „Setpoint curve“

In control modes five and six, the setpoint relationship is used when supply air control is active.

Use the eight breakpoints to generate a „setpoint“/“outdoor temperature“ relationship.

Temperature

Both the outdoor and supply air temperatures are changeable for the curve.

```
Outdoor comp. setp.
-20.0°C = 25.0°C
-15.0°C = 24.0°C
-10.0°C = 23.0°C
```

```
Outdoor comp. setp.
-5.0°C = 23.0°C
0.0°C = 22.0°C
5.0°C = 20.0°C
```

```
Outdoor comp. setp.
10.0°C = 18.0°C
15.0°C = 18.0°C
```

In-between-values are calculated using straight lines between breakpoints. Setpoints for temperatures lower than the lowest breakpoint and higher than the highest breakpoint are calculated by extending the line between the two last breakpoints at either end.

Example: At the lower end the setpoint is increasing by 1 °C for every 5 °C lowering of the outdoor temperature. So the setpoint at -23 °C would be 25 °C + .6x 1.0 °C = 25.6 °C.

Setpoint.

Control mode 3 and 5: Cascaded room temperature control.

```
Room temp.1
Actual: 22.0°C
Setpoint: 21.5°C →
```

In control mode 5, the setpoint is used when cascade connected room control is active.

Submenu for setting the min and max limitation temperatures for the supply air.

```
If cascade control
max/min supply setp.
Max: 30.0°C
Min: 12.0°C
```

If two room sensors have been configured you will also get the following menu:

```
Room temp.2  
Actual: 21.8°C
```

Control mode 4: Cascade connected extract air control, Control mode 6: Outdoor temperature-dependent supply or extract air control.

```
Extract air temp.  
Actual: 21.0°C  
Setpoint: 21.1°C
```

In control mode 6, the setpoint is used when cascade connected extract air control is active.

Submenu for setting the min and max limitation temperatures for the supply air.

```
If cascade control  
max/min supply setp.  
Max: 30.0°C  
Min: 12.0°C
```

Control mode 7: Outdoor temperature compensated room control.

```
Room temp1  
Actual: 22.0°C  
Setp.: 21.5°C →
```

```
Outdoor comp. setp.  
-20.0°C = 25.0°C  
-15.0°C = 24.0°C  
-10.0°C = 23.0°C
```

```
Outdoor comp. setp.  
-5.0°C = 23.0°C  
0.0°C = 22.0°C  
5.0°C = 20.0°C
```

Temperature

```

Outdoor comp. setp.
10.0°C = 18.0°C
15.0°C = 18.0°C
    
```

```

If cascade control
max/min supply setp.
Max: 30.0°C
Min: 12.0°C
    
```

In control mode 7, the room setpoint is compensated based on outdoor temperature. Note that the curve must be reset for optimum functionality.

Both the outdoor and room temperature are changeable for the curve.

Control mode 8: Outdoor temperature compensated extract air control.

```

Extract air temp
Actual: 21.0°C
Setp.: 21.1°C
    
```

```

Outdoor comp. setp.
-20.0°C = 25.0°C
-15.0°C = 24.0°C
-10.0°C = 23.0°C
    
```

```

Outdoor comp. setp.
-5.0°C = 23.0°C
0.0°C = 22.0°C
5.0°C = 20.0°C
    
```

```

Outdoor comp. setp.
10.0°C = 18.0°C
15.0°C = 18.0°C
    
```

```

If cascade control
max/min supply setp.
Max: 30.0°C
Min: 12.0°C
    
```

In control mode 8, the extract air setpoint is compensated based on outdoor temperature. Note that the curve must be adjusted for optimal functionality.

Both the outdoor and extract air temperature are changeable for the curve.

Support control heating

```
Support heating
Room temp for
Start: 15.0°C
Stop: 21.0°C
```

Support control cooling

```
Support cooling
Room temp for
Start: 30.0°C
Stop: 28.0°C
```

Frost protection temperature

```
Frost protection
Actual: 30.9°C
```

De-icing exchanger

```
De-icing exchanger
Actual: 11.2°C
Setpoint: -3.0°C
Hysteresis: 1.0°C
```

Heat exchanger efficiency monitoring

```
Support heating
Room temp for
Start: 15.0°C
Stop: 21.0°C
```

Temperature

 Recirculation (see section 6.1.12 *Recirculation*)

```
Temp.setpoint when
recirc. (Supply/
Extract/Room)
18.0°C
```

```
Offset SAF when
frequency control
and recirculation:
0.0 Pa
```

„Offset SAF“ makes it possible to add an offset to the setpoint during normal operation. If pressure control has been configured, the offset is set in Pa. If flow control has been configured, it is set in m³/h. If manual control has been configured, the offset is set in percent.

 Extra control circuit (see section 6.2 *Extra control circuit*)

```
Extra control circuit
Actual: 21.2°C
Setpoint: 20.0°C
```

Enthalpy control

```
Enthalpy indoor:
33.8 KJ/Kg
Enthalpy outdoor:
35.0 KJ/Kg
```

Submenus

```
Outdoortemp
Act.: 12.8 °C
Humidity Outdoor
Act.: 98.7% RH
```

```
Indoortemp
Act.: 17.2 °C
Humidity indoor
Act.: 55.7 % RH
```

Status enthalpy control

```
Override cool Recovery  
due to Enthalpy:  
Active
```

12 Air control

12.1 Pressure control SAF and EAF

When using pressure or flow controlled fans, the setpoint can be temperature compensated.

The compensation has the default value 0 Pa, i.e. no compensation is added. The compensation is linear between the setting points. The compensation can be positive or negative.

The same compensation normally applies to both fans. Using CASE flexotron, you can choose to compensate only the supply air fan.

The same compensation is applied to both „Normal“ and „Reduced“, which means that you need to take caution when using this function so the pressure does not become too low or even negative when running reduced speed.

Depending on the choice of fan control, different combinations of the menus below will be shown.

Pressure control SAF (there are corresponding menus for EAF).

```
Pressure contr. SAF
Actual: 480 Pa
Setp.: 490 Pa →
```

Submenu „Setpoint“

```
Pressure contr. SAF
Setp 1/1: 490 Pa
Setp 1/2: 300 Pa
```

Submenu „Outdoor compensation“

```
Outdoor comp.setp
-20°C = 490 Pa
10°C = 300 Pa
Act.comp = 0 Pa →
```

Air control

Submenu „Extra compensation curve“

```

Comp.sens.:Roomtemp1
15 °C = 0 Pa
20 °C = 0 Pa
25 °C = 0 Pa
    
```

Submenu “Controller output compensation if cooling”

```

Controller output
comp if cooling
0 at HCOUT= 0%
100 at HCOUT= 0%
    
```

Submenu “Controller output compensation if heating”

```

Controller output
comp if heating
0 at HCOUT= 0%
100 at HCOUT= 0%
    
```

The compensation follows the current control quantity, in this case pressure.

Submenu “Controller output compensation”

```

Controller output
compensation
Not active
    
```

Submenu “Compensation only when”

```

Compensation only
when:
1/1-speed: No
defrosting: No
    
```

Flow units can be measured in both m³/h (cubic meters per hour) and in CFM (cubic feet per minute).

Flow control SAF (there are corresponding menus for EAF).

```
Flow control SAF
Actual: 1800 m3/h
Setp.: 2000 m3/h  →
```

Submenu „Setpoint“

```
Flow control SAF
Setp 1/1: 2000 m3/h
Setp 1/2: 1000 m3/h
```

Submenu „Outdoor compensation“

```
Outdoor comp. setp.
-20 °C = 0.0 m3/h
 10 °C = 0.0 m3/h
Act. Comp: 0.0 m3/h
```

Submenu „Extra compensation curve“

```
Comp.sens.:Roomtemp1
15 °C = 0 m3/h
20 °C = 0 m3/h
25 °C = 0 m3/h
```

Submenu “Controller output compensation if cooling”

```
Controller output
comp if cooling
0 at HCOUT= 0%
100 at HCOUT= 0%
```

Submenu “Controller output compensation if heating”

```
Controller output
comp if heating
0 at HCOUT= 0%
100 at HCOUT= 0%
```

Air control

The compensation follows the current control quantity, in this case pressure.

Submenu "Controller output compensation"

```
Controller output
compensation
Not active
```

Submenu "Compensation only when"

```
Compensation only
when:
1/1-speed: No
defrosting: No
```

Flow units can be measured in both m3/h (cubic meters per hour) and in CFM (cubic feet per minute).

Manual frequency control SAF (there are corresponding menus for EAF).

```
Frequency control
manual SAF
Output: 75% →
```

Submenu „Setpoint“

```
Frequency control
manual SAF
Output 1/1: 75%
Output 1/2: 50%
```

Submenu „Outdoor compensation“

```
Outdoor comp. outp.
-20 °C = 0 %
10 °C = 0 %
Act. Comp: 0 %
```

Submenu „Extra compensation curve“

```
Comp.sens.:Roomtemp1
15 °C = 0 %
20 °C = 0 %
25 °C = 0 %
```

Submenu “Controller output compensation if cooling”

```
Controller output
comp if cooling
0 at HCOUT= 0%
100 at HCOUT= 0%
```

Submenu “Controller output compensation if heating”

```
Controller output
comp if heating
0 at HCOUT= 0%
100 at HCOUT= 0%
```

The compensation follows the current control quantity, in this case%. The function should not be used when fan setpoint is set to%, as the fans will then risk stopping in some modes.

Submenu “Controller output compensation”

```
Controller output
compensation
Not active
```

Submenu “Compensation only when”

```
Compensation only
when:
1/1-speed: No
defrosting: No
```

Flow units can be measured in both m³/h (cubic meters per hour) and in CFM (cubic feet per minute).

Air control

CO2

CO2
Actual: 920ppm
Setp: 850pm

13 Humidity control

Humidity control can be configured as Humidification, Dehumidification or both Humidification and Dehumidification.

Two humidity sensors can be connected, a room sensor for control and an optional duct sensor for maximum limiting. The limit sensor can be omitted.

The humidity control is handled by a PI-controller.

The humidity sensors must give 0...10 V DC for 0...100% RH.

Humidity sensor room

```
Humidity room
Actual: 51.9% RH
Setp: 50.0% RH
```

Humidity sensor duct

```
Humidity duct
Actual: 72.2% RH
Max limit: 80.0% RH
Hyst.: 20.0% RH
```

If the maximum limitation is 80% RH and the hysteresis is 20% RH, the controller output signal will begin decreasing at 60% RH. When halfway to 80% RH (i.e. when at 70% RH), half the output signal will be damped. If the humidity in the duct still reaches 80% RH, the entire output signal will be damped.

14 Time settings

General

The flexotron800 has a year-base clock function. This means that a week-schedule with holiday periods for a full year can be set. The clock has an automatic summertime/wintertime change-over.

Individual schedules for each week-day plus a separate holiday setting. Up to 24 individual holiday periods can be configured. A holiday period can be anything from one day up to 365 days. Holiday schedules take precedence over other schedules.

Each day has up to two individual running periods. For two-speed fans and pressure controlled fans there are daily individual schedules for normal speed and reduced speed, each with up to two running periods.

Up to 5 digital outputs can be used as timer controlled outputs. Each with individual week-schedules with two activation periods per day. These outputs can be used to control lighting, doorlocks etc

```
Time/Date
Timer Normal speed
Timer Reduced speed
Extended running
Timer output 1    →
Timer output 2    →
Timer output 3    →
Timer output 4    →
Timer output 5    →
Holidays         →
```

14.1 Time / Date

This menu shows and permits the setting of time and date.

Time is shown in 24-hour format.

Date is shown in the format YY:MM:DD.

```
Time: 18:21
Date: 13-01-09
Weekday: Wednesday
```

Time settings

14.2 Timer Normal speed

There are eight separate setting menus, one for each weekday and one extra for holidays.

Holiday schedules take precedence over other schedules.

For 24 hour running, set a period to 0:00–24:00.

To inactivate a period, set the time to 00:00–00:00. If both periods of a day are set to 0:00–0:00, the unit will not run at 1/1-speed that day.

```
Normal speed
Monday
Per 1: 07:00 - 16:00
Per.2: 00:00 - 00:00
```

If you want to run the unit from one day to another, e.g. from Mon 22:00 to Tue 09:00, the desired running time for both days must be entered.

```
Normal speed
Monday
Per 1: 07:00 - 16:00
Per.2: 22:00 - 24:00
```

```
Normal speed
Tuesday
Per 1: 00:00 - 09:00
Per.2: 00:00 - 00:00
```

14.3 Timer Reduced speed

These settings will be ignored if single speed fans are configured.

Should periods for normal speed and periods for reduced speed overlap, normal speed takes precedence.

There are eight separate setting menus, one for each weekday and one extra for holidays. Holiday schedules take precedence over other schedules. For 24 hour running, set a period to 00:00–24:00. To disable a period, set it to 00:00–00:00. If both periods of a day are set to 00:00–00:00, the unit will not run at „Reduced speed“ that day.

```
Reduced speed
Sunday
Per 1: 10:00 - 16:00
Per.2: 00:00 - 00:00
```

14.4 Extended running

Digital inputs can be used to force the unit to start although the timer says the running mode should be “OFF”.

For 2-speed fans and pressure/flow controlled fans, inputs for normal speed and reduced speed can normally be used.

The unit will run for the set time. If the running time is set to zero the unit will only run as long as the digital input is closed.

```
Extended running
60 min
Time in ext. Running
0 min
```

Time settings

14.5 Timer outputs 1...5

Up to 5 digital outputs can be used as timer controlled outputs. Each with individual week-schedules with two activation periods per day. Each output has eight separate setting menus, one for each weekday and one extra for holidays. Holiday schedules take precedence over other schedules.

Only the time channels which have been configured, i.e. have been wired to a digital output, will be shown.

```

Timer output 2
Wednesday
Per.1: 05:30 - 08:00
Per.2: 17:00 - 23:00
    
```

If the function „Recirculation“ has been configured (see 6.1.12 *Recirculation*), „Timer output 5“ can be used to control start/stop of the recirculation function.

14.6 Holidays

Up to 24 separate holiday periods for a full year can be set.

A holiday period can be any number of consecutive days from 1...365. The dates are in the format: MM:DD.

When the present date falls within a holiday period, the scheduler will use the settings for the weekday “Holiday”.

```

Holidays (mm:dd)
1: 01-01 - 02-01
2: 09-04 - 12-04
3: 01-05 - 01-05
    
```

15 Manual / Auto

General

In this menu the running mode of all the configured output signals and a number of control functions can be manually controlled. This is a very handy feature which simplifies the checking of individual functions in the flexotron800.

The running mode for the whole unit is set in the menu „Running mode“. See section 10 *Running mode*.

The supply air controller's output signal can be manually set (MANUAL/AUTO) to any value between 0 and 100%. The temperature output signals will change accordingly if they are in „Auto“ mode. It is also possible to manually control each of the temperature output signals individually.

All the configured digital outputs can be set to „AUTO“, „OFF“ or „ON“.

-  Since leaving any of the outputs in manual control will disrupt the normal control, an alarm will be generated as soon as any output is set to a manual mode.

Since the menus vary according to the configuration of the outputs only the most common ones will be shown here. For the digital signals you can normally choose between „AUTO“ and „ON“ and „OFF“ or similar words indicating the two possible manual states of the digital output.

MANUAL/AUTO

Supply air controller running mode can be set to „AUTO“, „ON“ or „OFF“. In manual „On“ mode the output signal can be set 0...100%. The outputs „Y1“, „Y2“ and „Y3“, if in „AUTO“ mode, will follow the signal according to the set split values.

```
Supply temp contr.
Auto
Manual set: 42.0
```

Start signal „SAF“ and „EAF“

Can be set to MANUL 1/1-speed, MANUAL 1/2-speed and OFF. MANUAL 1/2-speed is not valid for single speed fans.

```
SAF
Auto
```

Manual / Auto

```
EAF  
Auto
```

With pressure controlled fans you get the following menu: Can be set to „AUTO“, „MANUAL NORMAL“, „MANUAL REDUCED“, „MANUAL“ and „OFF“. In „MANUAL“ mode the output signal can be set 0...10 V.

```
Pressure SAF: Auto  
Manual set: 0.0
```

```
EAF: Auto  
Manual set: 0.0
```

Y1 heating output

```
Heating  
Auto  
Manual set: 0.0
```

Y2 heat exchanger

```
Exchanger  
Auto  
Manual set: 0.0
```

Y3 cooling

```
Cooling  
Auto  
Manual set: 0.0
```

Humidification/dehumidification

```
Humidification/Dehumidifi-  
cation  
Auto  
Manual set: 0%
```

Circulation pumps: Heating, Exchanger and Cooling

```
P1-Heating  
Auto  
P1-Exchanger  
Auto
```

```
P1-Cooling  
Auto
```

Dampers: Outdoor air, Recirculation air, Exhaust air and Fire dampers

```
Outdoor air damper  
Auto
```

```
Exhaust air damper  
Auto
```

Extra control circuit

```
Extra ctrl. unit  
Auto  
Manual set: 0.0
```

Extra sequence Y4

```
Extra sequence Y4  
Auto  
Manual set: 0.0
```

Extra sequence Y5

```
Extra sequence Y5  
Auto  
Manual set: 0.0
```

16 Settings

In this menu group all settings for all activated functions should be available. The menu group is only available when logging on as Admin. Depending on what choices have been made during configuration, some of the alternatives in this menu group may not be shown.

A complete overview of the menu structure is available in section 20 *Menu structure*.

Settings

```
Control temp
Control pressure
Control flow
Control humidity
Control CO2
Control extra unit
Alarm settings
```

16.1 Control temp

Supply air controller

```
Supply air control
P-band: 33.0 °C
I-time: 100.0 s
```

The set P-band for the supply air controller is for the whole controller signal. This means that the P-band for each sequence is proportionate to the split percentage values given to sequences.

For example:

P-band for the supply air controller is set to 25 K. The split is set so that cooling gets 0...20% = 20%, the exchanger gets 30...50% = 20% and the heater gets 50...100% = 50%.

The individual P-bands will then be:

Chiller: 20% of 25 °C = 5 °C

Exchanger: 20% of 25 °C = 5 °C

Heating: 50% of 25 °C = 12.5 °C

The remaining 2.5 °C are the neutral zone between cooling and exchanger.

Settings

The split values are set in the configuration submenu Other parameters.

```
If cascade control
max/min supply setp.
Max: 30°C
Min: 12°C
```

Room controller

```
Room control
P-band: 100.0 °C
I-time: 300.0 s
```

Extract air controller

```
Extract air control
P-band: 100.0 °C
I-time: 300.0 s
```

Shutdown mode

```
Shutdown mode
P-band: 100.0 °C
I-time: 100 s
```

Frost protection temperature

```
Frost protection tempera-
ture →
```

```
Frost protection
Active
Setp shutdown: 25°C
P-band active: 5°C
```

```
Fast stop at
frost-protection alarm
Yes
```

„Setp shutdown“ is the shutdown mode setpoint.

P-band active 5 °C means that the frost protection controller will start overriding the heating output when the frost protection temperature is less than five degrees above the set frost alarm limit. The default alarm limit is 7 °C. It can be changed in the menu Settings/Alarm settings/Alarm limits/Alarm limit frost protection.

Exchanger de-icing

```
De-iceing
P-band: 100 °C
I-time: 100 s
```

16.2 Control pressure

Pressure control SAF

```
Pressure control SAF
P-band: 500 Pa
I-time: 60 s
Min Output: 0 %
```

Pressure control EAF

```
Pressure control EAF
P-band: 500 Pa
I-time: 60 s
Min Output: 0 %
```

16.3 Control flow

Flow control SAF

```
Flow control SAF
P-band: 1000 m3/h
I-time: 60 s
Min Output: 0 %
```

Flow control EAF

```
Flow control EAF
P-band: 1000 m3/h
I-time: 60 s
Min Output: 0 %
```

Settings

16.4 Humidity control

```
Control humidity
P-band: 100.0 %RH
I-time: 300.0 s
```

16.5 Control Extra unit

```
Control extra
unit
P-band: 33.0 °C
I-time: 100.0 s
```

16.6 Alarm settings

Alarm settings

```
→Alarm limits
Alarm delays
Restore alarm
```

16.6.1 Alarm limits

Alarm limits, supply air

```
Al. lim. supply air
Control dev: 10.0 °C
High temp: 30.0 °C
Low temp: 10.0
```

Alarm limits, extract air

```
Al. lim. extract air
High temp: 30.0 °C
Low temp: 10.0 °C
```

Alarm limits, room

```
Al. lim. room air
High temp: 30.0 °C
Low temp: 10.0 °C
```

Alarm limit frost protection

```
Alarm limit frost
protection
7.0 °C
```

Alarm limit, pressure

```
Control dev SAF
40.0 Pa
Control dev EAF
40.0 Pa
```

Alarm limit Humidity

```
Control deviation
humidity
10 %
```

Alarm limit, exchanger efficiency

```
Low efficiency
50.0 %
```

Service alarm filter

```
Service alarm
(Filter alarm)
Time until alarm
Activates: 0 month
```

Settings

16.6.2 Alarm delays

Alarm delay, supply air

```
Al. del. supply air
Control dev: 30 min
High temp:   5 s
Low temp:    5 s
```

Alarm delay, extract air

```
Al. del. extract air
High temp:  30.0 min
Low temp:   30.0 min
```

Alarm delay, room

```
Al. del. room air
High temp:  30.0 min
Low temp:   30.0 min
```

Alarm delay, frost protection

```
Al. del. room air
High temp:  30.0 min
Low temp:   30.0 min
```

Alarm delay control SAF and EAF

```
Alarm delay control dev.
pressure
SAF:      30 min
EAF:      30 min
```

Alarm delay, Humidity

```
Alarm delay control
deviation humidity 30 min
```

Alarm delay, exchanger efficiency

```
Low efficiency  
30 min
```

Alarm delay, fan malfunction

```
Alarm delay malfunc.  
SAF: 120 s  
EAF: 120 s
```

Alarm delay, pump malfunction

```
Alarm delay malfunc.  
P1-Heating: 5 s  
P1-Cooling: 5 s  
P1-Exchan.: 20 s
```

Alarm delay, misc.

```
Filter guard1: 180 s  
Filter guard2: 180 s  
Flow switch: 5 s  
Frost prot.: 0 s
```

Ext. Frost prot. DI refers to the digital input signal Deicing Heat exchanger.

Alarm delay, misc. 2

```
Alarm delay  
Deicing DI: 0 s  
Fire alarm: 0 s  
Ext. alarm: 0 s
```

Frost protection DI refers to the digital input signal De-icing thermostat exchanger.

Alarm delay, misc. 3

```
Alarm delay  
Elec. heat: 0 s  
Sensor error: 5 s  
Rot.sent.exch:20 s
```

Settings

16.6.3 Restore alarm

```
Service alarm  
(filter alarm)  
Time counter set to  
zero: No
```

16.7 Save and restore settings

```
Restore factory  
settings: No  
Restore user settings: No
```

In this menu, it is possible to restore all parameters to their factory settings or to the user settings they were saved as earlier, see below.

```
Save user settings: No
```

The present configuration can be saved in a separate memory area and can later be restored using the previous menu, „Restore user settings“

17 Expansion model

2 and 3 port flexotron800 units are available on request with or without display. Both models have a TCP/IP port and one or two serial ports. For a list of the different models, see section 3.6 *flexotron800 model overview*.

17.1 Ports

The ports are used for connecting to CASE flexotron and possibly a SCADA system. On an WEB model, port 3 is the TCP/IP output.

The serial ports (ports 1 and 2) are used for expansion purposes, e.g for connection of expansion units, external display and Vacon NXL/Lenze SMV/Omron/Emerson/LS/EBM/Danfoss FC 101 frequency converters. A maximum of two frequency converters and two expansion units can be connected. The units must be flexotron800 controllers. There is no point in using slave controllers with a display, since the display cannot be used or show anything. However, an external display is required when initially starting up slave units without display. All configuration takes place using CASE flexotron, or via the display on the master controller. All inputs and outputs can be viewed in the master controller. For configuration, see section 18 *configuration*.

Version 3.1, frequency converters and expansion units can be used together.

Ports 1 and 2 have the same functions. They can, however, not be configured to have the same function at the same time. The TCP/IP port (port 3) can be used to load a web page to the unit. For more information, see the CASE flexotron manual.

17.2 Wiring

17.2.1 Vacon/Lenze/Omron/Emerson/LS/EBM frequency converters

If the flexotron800 is intended to control of one or two of the Vacon NXL/Lenze SMV/Omron V1000/Emerson frequency converters, Modbus communication via port two is utilised.

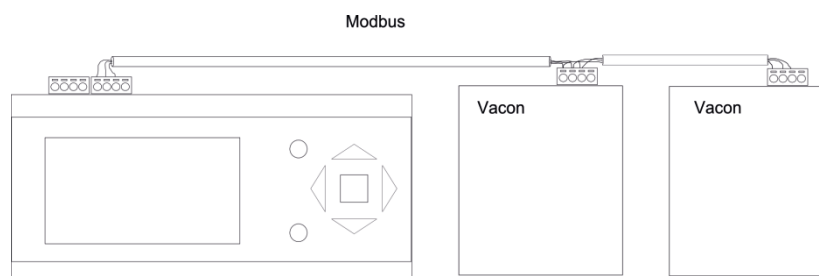

For additional settings for frequency converters, see appendix at the end of this document.

Expansion model

17.2.2 Expansion controllers

Communication between the master and expansion units takes place via priority bus. The slave controllers will be given the addresses 241:1 and 241:2 (ELA:PLA) respectively.

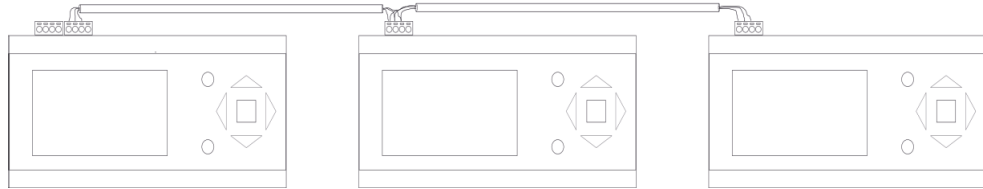

18 Configuration

Start by logging on as Admin. See section 9 *Access rights*.

Move the marker using the [DOWN] and [UP] buttons until it is opposite the menu "Configuration" and press [RIGHT].

The configuration main menu is shown (different menus are visible depending on the configured inputs and outputs).

A complete overview of the menu structure is available in section 20 *Menu structure*.

```
Inputs/Outputs
Sensor settings
Control function
Fan control
Extra control unit
Extra sequence Y4
Extra sequence Y5
Heating
Exchanger
Cooling
Pump control
Free cooling
Support control
CO2/VOC control
Fire function
Humidity control
Exchanger de-icing
Cooling recovery
Enthalpy control
Min lim. dampers
External setpoint
Run ind/Motor prot.
Type of actuator
Actuator run time
Actuat. Period time
Step controllers
Recirculation
Pretreatment
Alarm settings
Communication
Other parameters
System
```

Configuration

18.1 Inputs and outputs

```
AI
DI
UI
AO
DO
```

General

Free configuration

Any control signal can be bound to any in- and output, the only restriction being that digital signals cannot be bound to analogue inputs and vice versa. It is up to the user doing the binding to make sure that activated functions are bound to appropriate in- and outputs.

Delivery setting

On delivery all physical in- and outputs have already been bound to a signal. The delivery settings are suggestions only and can easily be changed.

18.1.1 Analogue inputs AI

```
AI1
Sign: Outdoor temp
Raw value: 18.4
Compensation:0.0
```

All analogue inputs are for Ni1000 or 0...10 V.

Input signals can be compensated e.g. for wiring resistance.

The raw value will show the actual, uncompensated input value.

If inputs have been assigned to pressure or flow control of fans, alternatively humidity or CO2 control, the following menus will appear:

```
SAF Pressure at
 0V: 0.0 Pa
10V:500.0 Pa
Filter factor: 0.2
```

```
CO2 at
0V: 0.0 ppm
10V: 2000 ppm
Filter factor: 0.2
```

Set the parameter values that should correspond to the input signal levels 0 V and 10 V. The filter factor is the damping you want the program to work with in order to reduce the influence of potential signal fluctuations on the sensor input. The filter factor can be changed via the display or CASE flexotron and is found after "analogue inputs" in "configuration". A new value is calculated using the following formula:

```
New value = old value * filter factor + raw value *
(1 - filter factor)
```

18.1.2 Digital inputs DI

```
DI1
NO/NC: NO Signal:
Filter alarm 1
Status: No
```

To simplify adaptation to external functions, all digital inputs can be configured to be either normally open, NO, or normally closed, NC.

The inputs are as standard normally open, i. e. if the input is closed, the function connected to the input in flexotron800 is activated.

Be careful when changing the input from NO to NC since some digital functions can be configured to either NO or NC themselves. For example, you can choose if the Fire alarm input should be activated when it is closed or opened. Therefore, there is a risk that the signal is changed twice and the result is the opposite of the desired.

18.1.3 Universal inputs UI

On the largest hardware version, RDT828 there are universal inputs. These can individually be configured as either analogue inputs or as digital inputs. When configured as analogue inputs they can be bound to any of the analogue signals described under Analogue signals.

When configured as digital inputs they can be bound to any of the digital signals described under „Digital signals“.

Configuration

```

UI1          →
Choose AI or DI sign
AI sign: SAF pressure
DI sign: Not used
    
```

After choosing AI or DI signal (the unused alternative must be set to not active) there are submenus with settings. These menus are accessed by pressing RIGHT.

```

UAI1
Sign: SAF pressure
Raw Value:8.5
Compensation: 0.0
    
```

```

UDI1
NO/NC: NO Signal
Not used
Status: No
    
```

To simplify adaptation to external functions, all universal inputs configured as digital inputs can be set to be either normally open, NO, or normally closed, NC.

The inputs are as standard normally open, i. e. if the input is closed, the function connected to the input in flexotron800 is activated.

Be careful when changing the input from NO to NC since some digital functions can be configured to either NO or NC themselves. For example, you can choose if the Fire alarm input should be activated when it is closed or opened. Therefore, there is a risk that the signal is changed twice and the result is the opposite of the desired.

18.1.4 Analogue outputs

Analogue outputs are 0...10 V DC.

```

AO1
Sign: Y1-Heating
Auto
Value: 0.0 V
    
```

Analogue outputs can be set in run mode „AUTO“, „MANUAL“ or „OFF“.

18.1.5 Digital outputs

```
DO1  
Signal: SAF 1/1-speed  
Auto  
Status: On
```

Digital outputs can be set in run mode „AUTO“, „MANUAL-ON“ or „MANUAL-OFF“.

18.2 Sensor settings

Ni1000 setpoint devices can be connected to function as outdoor and room temperature sensors. Alternatively, 0...10 V transmitters can also be used.

```
Room temp1  
Sensor type: Ni1000
```

If any of the sensors are set to 0...10 V, the sensor can be scaled using the right arrow key on the controller:

```
Room temp1  
0V = 0 °C  
10V = 100 °C
```

18.3 Control function

```
Control function  
Mode:  
Supply air control
```

There are 8 different control functions to choose from:

1. Supply air control.
2. Outdoor-temperature compensated supply air control.
3. Cascaded room temperature control
4. Cascade connected extract air temperature control.

Configuration

5. Outdoor temperature dependent switching between outdoor compensated supply air temperature control and room temperature control
6. Outdoor-temperature controlled switching between Outdoor-temperature compensated supply air control and Cascade connected extract air temperature control.
7. Outdoor compensated room temperature control
8. Outdoor compensated extract air control

For detailed description of the control modes, see section 6.1.2 *Control modes*.

In control modes five and six, there is a submenu for setting of the change-over outdoor temperature.

```
Outdoor temp for
control mode change
13.0 °C
```

18.4 Fan control

```
Fan control
1-speed
```

Choose between „Single-speed“, „Two-speed“, „Pressure control“, „Flow control“, „Frequency manual“ (fixed output), „Frequency external control“, „SAF with EAF slave“, or „SAF with EAF flow control“.

For detailed description of fan control alternatives, see section 6.4 *Fan control*.

18.4.1 Flow control

If flow control has been configured, there is a submenu for setting of calculation parameters for conversion of pressure to flow. There are two menus, one for „SAF“ and one for „EAF“.

```
SAF flow control
factors
K-constant: 100
X-constant: 0.50
```

For more detailed description, see section 6.4.1 *Pressure control*.

18.4.2 SAF with EAF slave / EAF with SAF slave

If fan slave operation has been configured, there is a submenu for setting the CAV factor, a factor which determines the slave fan output in relation to the output of the controlling fan.

```
SAF/EAF CAV factor: 1.00
```

For more detailed description, see section 6.4.5 *SAF with EAF slave*.

18.4.3 SAF with EAF flow control / EAF with SAF flow control

If fan slave operation and flow control has been configured, there are submenus for setting the flow calculation factors for „SAF“ and „EAF“, and the CAV factor for „SAF/EAF“.

```
SAF flow control  
factors  
K-constant: 100  
X-constant: 0.50
```

```
EAF flow control  
factors  
K-constant: 100  
X-constant: 0.50
```

```
SAF/EAF CAV factor: 1.00
```

For more detailed description, see section 6.4.7 *Frequency control SAF with flow control EAF* / 6.4.8 *Frequency control EAF with flow control SAF*.

Configuration

18.4.4 Crosswise interlock between fans

Crosswise interlock means that if one of the fans stops running, the other fan will automatically stop as well.

```
Crosswise interlock  
between SAF and EAF  
No
```

18.5 Extra control circuit

The extra control circuit can be configured to be either constantly active or to be active only when the regular control circuit.

```
Mode extra unit  
Running if  
unit runs
```

The extra control circuit can be configured to be either a heating or a cooling circuit.

```
Control mode extra unit:  
Heating
```

18.6 Extra sequence Y4

„Extra sequence Y4“ can be configured to one of the following alternatives: „Active“, „Active with cooling recovery“, „Active with enthalpy control“ and „Active with both cooling recovery and enthalpy control“.

```
Mode Extra Sequence Y4  
Not active
```

18.7 Extra sequence Y5

„Extra sequence Y5“ can be configured to “Active” or “Not active”.

```
Mode Extra Sequence Y5
Not active
```

18.8 Heating coil

```
Heating
Water
```

The heater can be set to „Water“, „Electric“, „Water/Electric“ or „Not used“.

For detailed description of heater alternatives, see section 6.1.3 Heater types.

18.9 Exchanger

```
Exchanger
Rot. Exch
```

The heat exchanger unit can be set to one of the following alternatives:

- Plate exchanger
- Rotating exchanger
- Liquid connected exchanger
- Mixing dampers
- Not connected
- Damper limiting for minimum outdoor air percentage is settable 0...100%.

In the submenu parameters for outdoor temperature control of exchanger can be set.

```
Outd. temp control of
exch: Off
Outd. temp start: 10°C
Diff. stop: 0.2°C
```

For detailed description of exchanger alternatives, see section 6.1.4 *Heat exchanger*.

Configuration

18.10 Chiller

```
Cooling
Water
```

Select chiller type: „Water“, „DX“, „DX with exchanger control“ or „Not used“.

For detailed description of DX-cooling, see section 6 *Functional description*.

If DX cooling has been configured, there are submenus for setting of certain operation parameters.

18.10.1 Min limit lowering

If DX cooling is used in combination with room or extract air control, the supply air temperature minimum limit value can be lowered to give smoother (more continuous) running of the chillers. The set lowering of the limit value is activated when the DX cooling is running.

```
Lowering of min
limit for supply air
control on active
DX cooling: 5.0°C
```

This parameter is also used for setting the lowering of the cooling setpoint when running „DX cooling with exchanger control“. See section 6 *Functional description*..

18.10.2 Blocking the DX cooling at low outdoor temp

Outdoor temperature dependent blocking of DX cooling is individually settable for each cooling step. If the outdoor temperature is below the set value, it is not possible to activate the cooling step. The function has a 1K hysteresis, i.e. if a cooling step is blocked, it can only be activated again when the outdoor temperature has risen to 1K above the set value.

```
Block DX-cooling,
step1, at outdoor temp.
lower than 13.0 °C
```

18.10.3 Blocking of DX cooling on cooling pump alarm

DX cooling can be blocked on activation of the cooling pump alarm.

```
Block DX-cooling on
alarm
"Run error P1-
cooler":No
```

18.10.4 Override of reduced speed for DX cooling

Override to normal quantity of air for DX cooling when the unit runs on reduced quantity of air. The fans can be set to normal operation when cooling is required at high outdoor temperatures (e.g. >14 °C, the same temperature limit as for blocking of DX cooling).

```
Force normal
speed if active
DX-cooling:Yes
```

18.11 Pump control

```
P1-Heating      →
P1-Exchanger    →
P1-Cooling      →
```

In these menus the parameters for pump control are set.

If, for any of the control circuits, no output is configured for pump control these settings will be ignored.

P1 Heating

```
Pump stop: Yes
Stop delay: 5 min
Outd. Temp stop: 10°C
Differential: 1.0°C
```

P1 Exchanger

```
P1-Exchanger
Stop delay: 5 min
```

Configuration

P1 Cooling

P1-Cooling
Stop delay: 5 min

For a detailed description of pump functions, see section 6.5 *Pump control*.

18.12 Free cooling

Free cool active:Yes
Outd. temp activation
22.0°C

Outd. Temp night
High: 18.0°C
Low: 10.0°C
Room temp min 18.0°C

Hour for start/stop
Free cooling
Start: 0
Stop: 7

Time to block heat output
after
free cooling 60 min

Fan output
when free cooling
SAF: 0 %
EAF: 0 %

Outdoor sensor
placed in intake channel
No

For detailed description, see section 6.1.7 Free cooling.

18.13 Support control

- i** If you select the function support control without EAF (extract air fan), a recirculation damper must be used. See more in section 6.1.6 *Support control*.

```
Support control
Active: Yes
EAF running during
support contr: Yes
```

Minimum running time

```
Min. run time for
support ctrl: 20 min
```

For detailed description, see section 6.1.6 *Support control*.

18.14 CO2 Demand control

```
CO2/VOC active
Never
Type: Mixing dampers
Min. time: 20 min
```

```
Activation level
1/2-speed: 800 ppm
1/1-speed: 1000 ppm
diff: 160 ppm
```

There is a detailed description in section 6.4.10.

18.15 Fire function

Fire dampers are normally configured to open on fire alarm.

However, they can be configured to be normally open instead via the display. You can use CASE flexotron to configure the air handling unit's running mode on fire alarm. The following options are available: „stopped“, „continuous run“, „run via normal start/stop conditions“, „only supply air fan in operation“ or „only extract air fan in operation“.

As of software version 3.2, fire alarm priority has been altered so that the unit will not stop for any other alarm (e.g. frost protection) when it has been configured for

Configuration

continued operation during fire alarms. The digital input "external switch" will still stop the unit. The fire alarm input can be configured to normally open or normally closed.

All dampers must be wired to the same output in order to get correct results.

```
Fire damper function
Not active
Operation when alarm
Stopped
```

Select if fire alarm should be normally closed or normally open and activation of fire damper exercising if the unit should be stopped or not: "No", "Yes unit running"→,"Yes unit stopped".

```
Fire alarm input
Normally open
Damper exercise
No
```

Set the parameters for damper exercise in the submenu.

```
Damper exercise
Running time: 90 s
Interval in days: 1
Hour for exerc.: 00
```

Running time is the time the damper actuator needs to open or close. Hour for exercise is the hour of the day at which you want the function to be run.

For detailed description of damper exercising, see section 6.6 *Damper control*.

18.16 Humidity control

Humidity control can be configured as either humidification or dehumidification or as combined humidification/dehumidification. These settings are for the digital output „Humidification/Dehumidification“.

```
Humidity control
Humid-/Dehumidificat
Start limit: 15%
Stop limit: 5%
```

For a detailed description, see section 6.3 *Humidity control*.

18.17 Exchanger de-icing

```
Exchanger de-icing  
Yes
```

De-icing parameters

```
Setp.De-icing:-3.0°C Hys-  
teresis: 1.0 °C  
Stoptemp SAF:-10.0°C  
Min. run time: 5 min
```

For detailed description of exchanger alternatives, see section 6.1.4 *Heat exchanger*.

18.18 Cooling recovery

```
Cooling recovery  
Off  
Cooling limit: 0.0°C
```

Cooling limit is the difference in temperature between extract air and outdoor air. For details, see section 6.1.8 *Cooling recovery*.

18.19 Minimum limit dampers

```
Min limit dampers  
Not active  
Min limit.: 5%
```

For detailed description of exchanger alternatives, see section 6.1.4 *Heat exchanger*.

18.20 Enthalpy control

```
Cooling recovery  
run when enthalpy is  
greater outdoor than  
indoor : Active
```

For a detailed description, see section 6.1.9 *Enthalpy control*.

Configuration

18.21 External setpoint

An external setpoint device can be connected. The setpoint device must follow the Ni1000 resistance curve. The setting range can be restricted.

```
External setpoint
Not active
Min setp.: 12.0°C
Max setp.: 30.0°C
```

For details, see section 6.1.11 *External setpoint*.

18.22 Run indication / Motor protection

Digital input signals are used to supervise fans and pumps. They can be configured either for indication of the motor running or for monitoring of motor protection contacts.

An input configured for run indication should normally be closed during operation.

Open input when the motor is running, i.e. motor control output is activated, will generate an alarm.

For supply air fans and extract air fans, there is also a conflict alarm, i. e. an alarm if the run indication input is closed even though the motor control output is not activated. See alarm 33 Supply Air Fan external operation and alarm 34 Extract Air Fan external operation in the section Alarm configuration.

An input configured as motor protection should be normally open, i. e. closed contact when the motor is running, i.e. motor control output is activated, will generate an alarm.

```
Run ind./Motor prot
SAF: Motor protection
EAF: Motor protection
```

```
Run ind./Motor prot
P1 Heat: Motor protection
P1 Exch: Motor protection
P1 Cool: Motor protection
```

When running frequency controlled fans, the pressure signal from each respective fan's pressure transmitter is normally used as run indication signal. If the pressure falls below the set value during normal operation, a malfunction alarm is activated.

```
Min pressure for  
run indication  
SAF: 25.0 Pa  
EAF: 25.0 Pa
```

18.22.1 Alarm from frequency converter

When running frequency controlled fans, you sometimes want to use both a pressure signal from a pressure transmitter and a digital alarm signal from a frequency converter. An analogue input for a pressure transmitter and a digital input for „SAF Indication“ or „EAF Indication“ must then be configured. The setting „Run indication/Motor protection SAF“ or „EAF Indication“ must be set to „Motor protection“. A fan alarm will be activated both when there is no pressure signal from the pressure transmitter, and when the digital signal „SAF Indication“ or „EAF Indication“ is activated.

18.23 Type of actuator

Choose output signals to the actuators connected to the analogue control outputs: 0...10 V DC, 2...10 V DC, 10...0 V DC or 10...2 V DC.

```
Type of actuator  
Y1 Heating: 0-10V  
Y2 Exchan.: 0-10V  
Y3 Cooling: 0-10V
```

```
Type of actuator  
SAF: 0-10V  
EAF: 0-10V  
Split: 0-10V
```

```
Type of actuator  
Y6 Humidity: 0-10V  
Extra unit: 0-10V  
Y1 Heat/Y3 cool 0-10V
```

```
Type of actuator  
Y4 Extra seq.: 0-10V
```

Configuration

```
Type of actuator
Y5 Extra seq.: 0-10V
```

i Even though many manufacturers state 0...10 V DC as control signal, for many actuators the actual control signal is more often than not 2...10 V DC. Check the actuator documentation carefully. If uncertain, choose 0...10V DC. Although control might be less accurate, it will ensure that the valve always can be driven to its fully opened and fully closed positions.

18.24 Running time, 3-position actuators

These parameters have no function if analogue actuators are configured. The values are used to determine the control parameters for 3-position actuators. It is important to set correct values since incorrect values lead to sloppy control.

```
Actuator run time
Heating: 255 s
Exchanger: 255 s
Cooling: 255 s
```

18.25 Step controllers

```
Step contr. heating →
Step contr. Cooling →
```

18.25.1 Step controller heating

Step controller heating can be set to sequential or binary.

```
Step contr. heating →
Step contr. Cooling →
```

Step controller Heating activation levels for sequential control. For binary control the activation levels are calculated by the controller depending on the number of steps involved.

```
Start step 1: 10 %  
Stop step 1: 5 %  
Start step 2: 45 %  
Stop step 2: 40 %
```

```
Start step 3: 70 %  
Stop step 3: 65 %  
Start step 4: 95 %  
Stop step 4: 90 %
```

Control parameters. Heater groups is used to calculate activation levels for binary control. „Hyst.“ is the switching differential used for each step when running binary control.

```
Heater groups: 4  
Minimum on/off-  
time: 60 s  
Hyst.: 0.5 %
```

18.25.2 Step controller cooling

„Step controller Cooling“ can be set to sequential or binary.

```
Step contr. cooling  
Sequential →
```

„Step controller Cooling“ activation levels for sequential control.

For binary control the activation levels are calculated by the controller depending on the number of steps involved

```
Start step 1: 10 %  
Stop step 1: 5 %  
Start step 2: 50 %  
Stop step 2: 45 %
```

```
Start step 3: 95 %  
Stop step 3: 90 %
```

Configuration

Control parameters. Chiller groups is used to calculate activation levels for binary control. "Hyst." is the switching differential used for each step when running binary control.

```
Chiller groups: 3
Minimum on/off-
time: 60 s
Hyst.: 0.5 %
```

When DX cooling is used in conjunction with pressure controlled or flow controlled fans it is possible to block DX cooling if the supply air fan control signal falls below a preset values. The blocking level is individually settable for each DX cooling step.

```
At lower SAF-output
block step 1: 0 %
block step 2: 0 %
block step 3: 0 %
```

For a more detailed description, see section 6.1.2 Control modes.

18.25.3 Step controllers Change-over

The digital output signals „Heating/cooling step 1“, „Heating/cooling step 2“ and „Heating/cooling step 3“ are used for step controllers during Change-over control (see section 6.1.13 *Change-over*). They have the same functions as other step controller outputs, but are set to either heating or cooling depending on whether heating or cooling is required. In other words, when heating is active, they will follow the settings for „Heating 1-3“ and when cooling is active they will follow the settings for „Cooling 1-3“.

18.26 Recirculation

Recirculation is a function for distributing the air in the room using the supply air fan. The extract air fan can also be used, if desired. The function can be used even when there is no heating or cooling demand. When using recirculation control, the extract air fan stops and a recirculation damper opens which allows the air to circulate through the unit.

Either a digital output (Recirculation damper) or an analogue output (Y4 Extra sequence) can be used as an output signal. When Y4 Extra sequence is used, the damper will become modulating.

```
Enable temp control
when recirculation:
No
```

Recirculation control can be configured as either air circulation (temperature control inactive) or air circulation with temperature control. (Only heating, only cooling or both heating and cooling.) Recirculation control can either have a unique setpoint or follow the supply air setpoint, with an adjustable offset. The other settings are the same as for normal operation, i.e. if normal operation has been configured as room control, room control will also be used during recirculation.

```
End recirculation  
control when room  
temp. exceeds:  
25.0°C
```

If the room temperature rises above the set limit value, recirculation will be stopped.

```
Enable free cool  
when recirculation:  
No
```

To lower the temperature, it is possible to configure free cooling to be used during recirculation, if the conditions for free cooling are fulfilled.

```
Use extra time  
group 5 to start  
recirculation: No
```

Recirculation is activated either via a digital input signal or by connecting it to „Timer output 5“.

```
EAF in operation at  
recirculation: No
```

The extract air fan can be selected to run during recirculation.

18.27 Pretreatment

Control of dampers and pump for preheated or pre-cooled outdoor air via an underground intake channel. The digital output "Pretreatment" is set to preheating when the unit is started and the outdoor temperature is below the set heating start limit (default 8 °C) or to precooling when the outdoor temperature is above the set cooling start limit (default 19 °C).

Configuration

If the outdoor temperature exceeds the set heating start limit by more than 1 °C (fixed), preheating will be aborted, as well as if the outdoor temperature falls below the cooling start limit by 1 °C.

If a sensor is configured in the intake duct ("intaketemp") this temperature will be compared with the outdoor temperature. If the temperature in the intake duct does not exceed the outdoor temperature by more than 1 °C (adjustable) 5 minutes (fixed) after start-up when using preheating, preheating will be aborted. The same conditions apply to precooling, i.e. if the intake temperature is not more than 1 °C (adjustable) cooler than the outdoor temperature, precooling will be aborted.

Pretreatment always starts at start-up of the unit, if the outdoor temperature so permits. If pretreatment is aborted due to a small difference between the intake temperature and the outdoor temperature, pretreatment will be blocked for 6 hours. Then pretreatment will start (if the outdoor temperature so permits) and run for at least 5 minutes.

```

Outdoortemp for
activating
preheating: 8.0 °C
precooling: 19.0°C
    
```

```

Minimum diff.
outdoortemp-
intaketemp: 1.0°C
    
```

18.28 Alarm setting

Permits configuration of all alarms.

Select the appropriate alarm number (from the alarm list). The alarm text for the alarm will be displayed and the alarm priority can be set; „A-alarm“, „B-alarm“, „C-alarm“ or „not active“. The extra stop function gives, for each alarm, the option to stop or not stop the unit on alarm activation.

```

Run Error supply air
Priority: B-alarm
Extra stop function
Active
    
```

18.28.1 Alarm text

The alarm text that should be shown in the display when there is an alarm can be changed using CASE flexotron. For more information, see the CASE flexotron manual.

Alarm list

The alarm text and priority columns show the factory set values.

	Alarm text	Pri	Description
1	Run Error Supply Air Fan	B	Malfunction Supply air fan
2	Run Error Extract Air Fan	B	Malfunction Extract air fan
3	Run Error P1-Heater	B	Malfunction pump, Heating circuit
4	Run Error P1-Cooler	B	Malfunction pump, Cooling circuit
5	Run Error P1-Exchanger	B	Malfunction pump, Liquid connected exchanger
6	Filter guard 1	B	Filter guard 1 pressure switch activated
7	Flow switch	B	Flow switch activated
8	External frost guard	A	External Frost protection thermostat activated
9	Deicing pressure guard	-	Exchanger de-icing pressure switch activated
10	Fire alarm	A	Fire alarm activated
11	External switch	C	"External switch" activated
12	External alarm	B	External alarm activated
13	Supply Air control error	B	Supply air temp deviates too much from the setpoint for too long.
14	Humidity control error	-	The room humidity deviates too much from the setpoint.
15	High supply air temp	B	Supply air temp too high
16	Low supply air temp	B	Supply air temp too low
17	Supply air temp max	-	Maximum limiting of supply air temp active
18	Supply air temp min	-	Minimum limiting of supply air temp active
19	High room temp	B	Room temp too high during room temp control
20	Low room temp	B	Room temp too low during room temp control
21	High extract air temp	B	High extract air temp during extract air control
22	Low extract air temp	B	Low extract air temp during extract air control
23	Electric heating is overheated	A	Heater high temperature limit switch activated
24	Frost risk	B	Frost protection function is overriding the control of the heater output
25	Low frostguard temp	A	Frost protection temperature below frost limit value
26	Low efficiency	B	Heat exchanger efficiency below limit value
27	Sensor error Outdoor temp	B	Malfunction of connected sensor

Configuration

	Alarm text	Pri	Description
28	Analogue de-icing	-	Exchanger de-icing activated by de-icing sensor
29	Rotation guard exchanger	B	Exchanger rotation sentinel alarm activated
30	Fire damper is out of operation	B	Fire damper exercise test failed
31	Supply Air Fan control error	-	Supply air pressure deviates too much from the setpoint for too long.
32	Extract Air Fan control error	-	Extract air pressure deviates too much from the setpoint for too long.
33	Supply Air Fan external operation	C	SAF run-signal received when unit is stopped
34	Extract Air Fan external operation	C	EAF run-signal received when unit is stopped
35	Ventilation Manual mode	C	The unit is in manual mode
36	Manual supply air control	C	Supply air temp controller in manual control
37	Manual supply Air Fan mode	C	Supply air fan in manual control
38	Manual Supply Air	C	The SAF is in manual mode
39	Manual Extract Air Fan mode	C	Extract air fan in manual control
40	Manual Extract Air	C	The EAF is in manual mode
41	Manual Heater Control	C	The heater is in manual mode
42	Manual exchanger control	C	Heat exchanger output in manual control
43	Manual cooler control	C	Cooling output in manual control
44	Manual P1-Heater	C	Heating circulation pump in manual control
45	Manual P1-Exchanger	C	Exchanger circulation pump in manual control
46	Manual P1-Cooler	C	Cooling circulation pump in manual control
47	Fire damp. Manual	C	Fire dampers in manual control
48	Internal battery error	A	Internal battery needs replacing
49	Sensor error Supply Air temp	B	Malfunction of connected sensor
50	Sensor error Extract Air temp	B	Malfunction of connected sensor
51	Sensor error Room temp 1	B	Malfunction of connected sensor
52	Sensor error Room temp 2	B	Malfunction of connected sensor
53	Sensor error Exhaust air temp	B	Malfunction of connected sensor
54	Sensor error Extra sensor	B	Sensor error Extra sensor 1
55	Sensor error SAF pressure	B	Malfunction of connected sensor
56	Sensor error EAF pressure	B	Malfunction of connected sensor
57	Sensor error Deicing temp	B	Malfunction of connected sensor
58	Sensor error Frost Protection temp	B	Malfunction of connected sensor
59	Sensor error CO2	B	Malfunction of connected sensor
60	Sensor error Humidity Room	B	Malfunction of connected sensor
61	Sensor error Humidity Duct	B	Malfunction of connected sensor
62	Sensor error Extra unit temp	B	Malfunction of connected sensor
63	Sensor error External control SAF	B	Malfunction of connected sensor
64	Sensor error External control EAF	B	Malfunction of connected sensor
65	Sensor error SAF Pressure 2	B	Malfunction of connected sensor

	Alarm text	Pri	Description
66	Sensor error Humidity outdoor	B	Malfunction of connected sensor
67	Sensor error Intake temp	B	Malfunction of connected sensor
68	Sensor error Extra sensor 2	B	Malfunction of connected sensor
69	Sensor error Extra sensor 3	B	Malfunction of connected sensor
70	Sensor error Extra sensor 4	B	Malfunction of connected sensor
71	Sensor error Extra sensor 5	B	Malfunction of connected sensor
72	Sensor error Extra SAF pressure	B	Malfunction of connected sensor
73	Sensor error Extra EAF pressure	B	Malfunction of connected sensor
77	Alarm frequency converter SAF	B	Malfunction of frequency converter SAF
78	Alarm frequency converter EAF	A	Malfunction of frequency converter EAF
79	Communication error Frequency SAF	C	Communication error Vacon NXL/Lenze SMV/Omron V1000/Emerson
80	Communication error Frequency EAF	C	Communication error Vacon NXL/Lenze SMV/Omron V1000/Emerson
81	Communication error Expansion unit 1	C	Communication problem with connected expansion unit
82	Communication error Expansion unit 2	C	Communication problem with connected expansion unit
83	Warning Frequency converter SAF	C	Alarm from frequency converter via Modbus communication
84	Warning Frequency converter EAF	C	Alarm from frequency converter via Modbus communication
85	Output in manual mode	C	Analogue or digital output in manual mode
86	Time for service	C	Time for service
87	Manual Y4-Extra Sequence control	C	Y4-Extra sequence in manual control
88	Restart blocked after power on	B	Restart blocked due to earlier power failure
89	Manual Y5-Extra Sequence control	C	Y5 Extra sequence in manual control
90	Filter guard 2	B	Filter guard pressure switch activated
91	High temp Extra sensor 1	-	High temperature Extra sensor 1
92	Low temp Extra sensor 1	-	Low temperature Extra sensor 1
93	High temp Extra sensor 2	-	High temperature Extra sensor 2
94	Low temp Extra sensor 2	-	Low temperature Extra sensor 2
95	High temp Extra sensor 3	-	High temperature Extra sensor 3
96	Low temp Extra sensor 3	-	Low temperature Extra sensor 3
97	High temp Extra sensor 4	-	High temperature Extra sensor 4
98	Low temp Extra sensor 4	-	Low temperature Extra sensor 4
99	High temp Extra sensor 5	-	High temperature Extra sensor 5
100	Low temp Extra sensor 5	-	Low temperature Extra sensor 5

Configuration

18.29 Communication

18.29.1 Modbus communication

The flexotron800 can be connected to a network for Modbus communication.

```
Modbus slave communication, Port 1
Not Active
```

If Modbus communication is activated, you can set the address etc. Modbus communication takes place using 1 stop bit.

```
Modbus Address: 1
Speed: 9600 bps
Two stop bits:Yes
Parity:No
```

 Only one stop bit can be used.

Slave

For connection to CASE flexotron and a Modbus SCADA system.

```
Function Port 1 →
Slave
```

Expansion unit

In order to connect additional I/Os (in- and outputs) to the flexotron800, port 1 and 2 should be set as an expansion unit (only flexotron800 controllers can be connected). It is possible to connect 2 expansion units, giving a maximum number of $28 \times 3 = 84$ inputs/outputs. The expansion units must have the addresses 241:1 and 241:2 respectively (ELA:PLA).

```
Expansion unit 1
None
Expansion unit 2
None
```

To initiate the expanded controllers, select "Expansion unit" at start-up (see below). If the controller does not contain program version 3.0 or later, the initiation must be made via CASE flexotron (see the CASE flexotron manual). After initiating the expansion units and setting the master controller, all inputs and outputs are available for configuration in the master controller under

„Configuration“ / „Inputs/Outputs“ (the expansion ‘units’ in-/outputs are named Exp1/Exp2).

```
flexotron800 Vent.  
flexotron800 Heat.  
Expansion Unit 1  
Expansion Unit 2
```

Frequency converters

Up to two separate Vacon NXL / Lenze SMV / Omron V1000 / Emerson Commander / LS iG5a / LS iS7 / EBM-PABST / Danfoss FC 101 frequency converters can be controlled via Modbus communication. Miscellaneous alarms and indications can be read from the frequency converters. For a complete list of alarms, see the alarm list. For communication addresses, see the flexotron800 variable list. Information is also available at the end of this manual.

The flexotron800 Modbus settings are listed below. They are not adjustable and must also be set in the Vacon NXL/Lenze SMV/Omron V1000/Emerson Commander/ LS iG5a / LS iS7 / EBM-PABST / Danfoss FC 101 frequency converters.

Modbus address: Supply air fan = 1, Extract air fan = 2
Speed: 9600 bps, 1 stop bit, no parity

For additional settings for every model, see Appendix 1 at the end of this document.

```
Type of frequency  
converter connected  
via Modbus:  
Vacon NXL
```

Expansion unit and frequency converters

Frequency converters can be used in combination with expansion units on the same port. The master controller will switch the port between Modbus and proprietary protocol in order to communicate with the frequency converters via Modbus and with the expansion unit via proprietary protocol.

```
Function Port 1  
Exp.and freq conv
```

Press RIGHT to select which expansion units are to be connected.

Configuration

```
Expansion unit 1
None
Expansion unit 2
None
```

Then go a step down to select which frequency converters are to be connected. For additional settings for frequency converters, see appendix at the end of this document.

```
Type of frequency
converter connected
via Modbus:
None
```

Expansion unit and external display

```
Function Port1      →
Exp and ext display
```

An expansion unit and external display can be used on the same port simultaneously.

18.29.2 Function port 2

In a flexotron800 with 3 ports, both serial ports have the same function. They can, however, not be configured to have the same function at the same time.

18.29.3 BACnet communication

In order to connect a flexotron800 running a ventilation application to a SCADA system via BACnet/IP, a flexotron800 V2 controller with a TCP/IP port is required. BACnet communication cannot be activated via the display. It must instead be activated using CASE flexotron.

For additional information, see the PICS document and variable list available via www.sauter-controls.com.

18.30 Other parameters

18.30.1 Start and stop delays for the fans

Use start delay if you wish one of the fans to start before the other and for example if you wish to give the close-off dampers time to open before starting the fans. Use stop delay e.g. to create a cool-down period when using electric heating. In order to avoid letting in too cold air, e.g. in the winter, the heat exchanger will continue to run during the stop delay.

```
Delay SAF
Start: 60 s
Stop: 30 s
```

```
Delay EAF
Start: 0 s
Stop: 30 s
```

18.30.2 Retardation time

When switching two-speed fans from 1/1-speed to 1/2-speed there is a settable retardation time. The same time applies to both fans.

```
Retardation time
1/1-1/2speed: 10 s
```

18.30.3 Heating at start-up and high speed blocking

At outdoor temperatures below the set value, the heating output will be forced to 100% before start-up.

Two speed fans and pressure controlled fans can be blocked from using high speed at outdoor temperatures lower than the set value. This function should not be combined with the function "Outdoor compensation of pressure setpoint". See section 6.4.10 *Demand control ventilation*.

Both functions need an outdoor temperature sensor.

```
Outd.temp for
heat start: 3.0°C
Blocking of
1/1-speed: -10°C
```

18.30.4 Start delay exchanger

```
Startdelay Exch.
0 s
```

Configuration

18.30.5 Exchanger to 100% at start and alarm delay at start

To minimise the risk of freeze-up problems, the heat exchanger can be forced to maximum capacity for the set time at start-up.

To eliminate the risk of, for example, fan pressure alarms at start-up, all alarm functions can be suppressed for the set time.

```
Exch 100% at start
2 s
Alarm delay at start
60 s
```

For the function "Slave control of the extract air fan", the fan will start directly at 50% after the start delay, in order for the heating of the exchanger to work for this operating mode. When the supply air fan starts, the extract air fan will be slave controlled by the flow in the supply air duct.

18.30.6 Split controller signal

Splits the controller output (Heating Controller Output signal = HCO_{out}) between the analogue temperature control output signals Y1, Y2 and Y3 for „Heating“, „Heat exchanger“ and „Cooling“.

To create a neutral zone, leave a percentage gap between sequences.

The set P-band for the supply air controller is for the whole controller signal. This means that the P-band for each sequence is proportionate to the split percentage values given to sequences.

Example:

P-band for the supply air controller is set to 33K. The HCO is set so that cooling gets 0...30% = 30%, the exchanger gets 32...50% = 18% and the heater gets 54...100% = 46%. The individual P-bands will then be:

Chiller: 30% of 33 °C = 10 °C

Exchanger: 18% of 33 °C = 6 °C

Heating: 46% of 33 °C = 15 °C

The remaining 2 °C are the neutral zone between cooling and exchanger.

```
Split settings
Exchanger
 0% at HCOout= 32%
100% at HCOout= 50%
```

Split settings
 Heating
 0% at HCOut= 54%
 100% at HCOut= 100%

Split settings
 Cooling
 0% at HCOut= 30%
 100% at HCOut= 0%

Split settings
 Extra Sequence Y4
 0% at HCOut= 0%
 100% at HCOut= 0%

Split settings
 Extra Sequence Y5
 0% at HCOut= 0%
 100% at HCOut= 0%

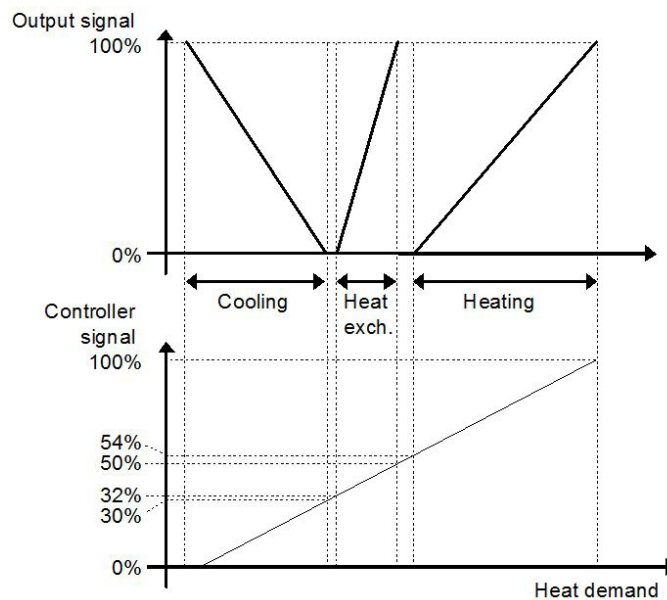

Configuration

18.30.7 Outdoor temp. for control mode change

If the unit is configured for combined Supply air/Room control this menu permits the setting of the change-over outdoor temperature.

```
Outdoor temp for  
control mode change  
13.0°C
```

18.30.8 Split of optional temp. sequence

Any one of the analogue temperature control output sequences „Y1“, „Y2“ and „Y3“, “Y1 Heating/Y3 Cooling”, “Y4-extra sequence” can be split, for example to control two heating valves in sequence.

The split is always even, 50/50, which means that each part of the split will have half the part of the P-band assigned to the output. An analogue output must be assigned to the output signal “Split”. On increasing output demand, the regular output is always run first and then the output that has been configured as Split.

```
Split optional  
temperature sequence  
Y1 Y2 Y3  
No split
```

18.30.9 Fast stop on overheating

If this function is active, the fans will be immediately stopped when there is an overheating alarm, regardless of the set cool-down time.

```
Fast stop on alarm  
“Electric heating is  
overheated”: No
```

18.30.10 Automatic restart at power-up

The function “Automatic restart at power-up” makes it possible to block automatic restart of the unit at power-up. At power-up, the B-alarm “Restart blocked after power on” is generated. Once this alarm has been acknowledged, the unit will start.

```
Automatically  
restart after  
power on:  
Yes
```

18.31 System

18.31.1 Change language

Use this menu to change the display language.

```
Choose language
English
```

-  This menu is also directly accessible by holding the [OK] button depressed during power-up or by pressing right arrow three times when the start display is shown.

The different language files are stored in the application memory and are downloaded to the work memory. If a flexotron800 via CASE flexotron has been reloaded with a newer program revision than the factory revision, the controller will not allow language files to be downloaded from the application memory. This is because there is a risk that the language files are not compatible with the new revision. Therefore, you are limited to the two languages you have downloaded using CASE flexotron.

18.31.2 Choose start display, the text normally shown on the display

There are five different to choose from.

Type 1

The text on the first line can be changed using CASE flexotron.

The second line shows the date and time.

The third line shows the present running status.

The fourth line shows the present temperature setpoint and actual values.

```
Flexotron 800
2004-08-15 11:28
System: Running
Sp:22.0°C Act:21.8°C
```

Type 2

The first line shows the date and time.

The second line shows the present running status.

The third line shows the present temperature setpoint and actual values.

The fourth line shows the present temperature control output values.

```
2004-08-15 11:28
System: Running
Sp:22.0°C Act:21.8°C
Y1:0% Y2:93% Y3:0%
```

Configuration

Type 3

The first line shows the date and time.

The second line shows the present running status.

The third line shows the present temperature setpoint and actual values.

The fourth line shows the present SAF and EAF pressures.

```
15/03/2004 11:28
System: Running
Sp:22.0°C Act:21.8°C
SAF:1100Pa EAF:1050Pa
```

Type 4

The text on the first line can be changed using CASE flexotron.

The second line shows the date and time.

The third line shows the present running status.

```
Vent Sys Controller
2004-03-15 11:28
System: Running
```

Type 5

The text on the first line can be changed using CASE flexotron.

The second line shows the date and time.

```
Vent Sys Controller
2004-03-15 11:28
```

18.31.3 Automatic summer-/wintertime change-over

When flexotron800 is set on automatic summertime/wintertime change-over, the timer will automatically change between summertime and wintertime according to European standard.

```
Automatic summer/
winter time change
over
Yes
```

18.31.4 Address

The flexotron800 uses the addresses below when connecting to CASE flexotron, and when multiple controllers are connected in a network. CASE flexotron normally uses the addresses below, so if an address is changed, the new address must also be entered in CASE flexotron. If several flexotron800 are connected in a network, all the units must have the same ELA address, but each unit must have a unique PLA address.

```
Address
PLA: 254
ELA: 254
```

18.31.5 Display anywhere (remote control)

If multiple flexotron800 units are connected in a network, it is possible to remote control a unit in the network from a unit with display. You do this by entering the address of the unit you wish to remote control in the unit with display. The function is aborted by pressing the buttons [UP], [OK] and [DOWN] simultaneously.

```
Address for remote commu-
nication
(PLA:ELA) : 00:00
```

18.31.6 Automatic logoff

If the access level is Operator, Service or Admin, the user will automatically be logged off to Normal after a settable time of inactivity. The time is settable in units of 5 seconds. Standard 60 units = 5 minutes.

The automatic logoff can be removed, see section 9.4. *Change password to remove automatic logoff*

```
Time before user
automatically
logged off:60
(Unit 5 s)
```

18.31.7 Activation of start-up wizard

The start-up wizard is a special program which at the first start-up guides the operator through a number of start-up menus where you set certain operation parameters. For more information, see section 21.1 *Start-up wizard*.

```
Activate wizard
No
```



19 Other functions

19.1 Alarm handling

If an alarm condition occurs, the red Alarm LED on the front panel of units with display or the Alarm LED on a connected display unit will start flashing. The LED will continue to flash as long as there are unacknowledged alarms.

Alarms are logged in the alarm list. The list shows type of alarm, date and time for the alarm and the alarm class (A, B or C alarm).

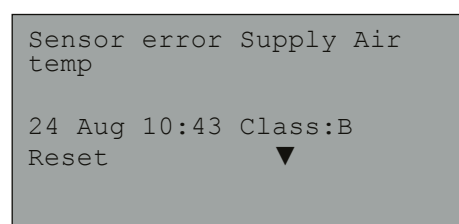
To access the alarm list, press the [alarm] button, the front panel button with the red button-top, on the front of the flexotron800 / RDB800



```
Sensor error Supply Air
temp
24 Aug 10:43 Class:B
Reset ▼
```

If there are multiple alarms, this is indicated by Up/Down arrow symbols at the right-hand edge of the display.

Use the [Up] and [Down] buttons to access the other alarms.

At the left end of the bottom display line the alarm status is shown. For active, unacknowledged alarms the space is blank. For alarms that have reset the text "Reset" is shown. Acknowledged, still active or blocked alarms are indicated by Acknowledged or Blocked.

Alarms are acknowledged by pressing the [OK] button. You are then given the choice of acknowledging the alarm or blocking the alarm.

Acknowledged alarms will remain on the alarm list until the alarm input signal resets. The LED is then lit.

Blocked alarms remain on the alarm list until the alarm has reset and the block has been removed. New alarms of the same type will not be activated as long as the block remains.



Since blocking alarms can be potentially hazardous, you need a high user access to block alarms.

Class A and B alarms will activate alarm output(s) if these have been configured.

Class C alarms do not activate the alarm output(s).

Class C alarms are removed from the alarm list when the alarm input resets even if the alarm has not been acknowledged.

Other functions

19.2 Free text

If [RIGHT] is pressed once when the start-menu is shown, a menu showing text of your choice is displayed. The text can be used to show information concerning the commissioning company, name and phone number to service personnel etc. The easiest way to enter text is to use CASE flexotron, but the buttons can also be used. Four lines of 20 characters.

19.3 Revision number

If [RIGHT] is pressed twice when the start-menu is shown, a menu showing the program revision number i.e. the date on which the program was created, and the flexotron800 ID number (not to be confused with its serial number) is displayed.

19.4 Language



When the start menu is displayed, pressing the [RIGHT] button three times will display a menu in which the language can be changed.

The different language files are stored in the application memory and are downloaded to the work memory. If a flexotron800 via CASE flexotron has been reloaded with a newer program revision than the factory revision, the controller will not allow language files to be downloaded from the application memory. This is because there is a risk that the language files are not compatible with the new revision. Therefore, you are limited to the two languages you have downloaded using CASE flexotron.

19.5 Indication LEDs

Status indication can be found in the upper left corner of the master controller. For controllers with display, the alarm indication and change mode LEDs are located in the keypad area.

Status indication

Designation	Colour	Description
P1 RxTx	yellow/green	Interface 1, send/receive
P2 RxTx	yellow/green	Interface 2, send/receive
TCP/IP (TCP-models)	yellow/green	Green: Connected to other network equipment Blinking green: Network traffic Blinking yellow: For identifying
P/B (Power/Battery)	green/red	Power on/Battery error
Controllers with built-in display:		
	red	Alarm indication
	Yellow	Change mode

20 Menu structure

A simplified overview of the menu structure of the flexotron800 shows the following. The menu items shown are dependent on the active operating level and on the current configuration.

Running Mode

Running mode

Selected functions

Alarm events

Input / Output

Temperature

Setpoint

Support control heating

Support control cooling

Frost protection temperature

De-icing temperature

Heat exchanging

Recirculation

Extra control circuit

Entahalpy control

Air control

Pressure control

Flow control

Frequency Control manual

CO₂ / VCO

Humidity control

Humidity sensor room

Menu structure

Humidity sensor duct

Time settings

Time/Date

Timer Normal Speed

Timer Reduced Speed

Extended running

Holidays

Manual / Auto**Settings**

Control temp

Control pressure

Control flow

Control Humidity

Control CO2

Control extra unit

Alarm settings

Alarm limits

Alarm delays

Restore alarms

Save and restore settings

Configuration

Inputs / Outputs

Sensor settings

Fan control

SAF flow factors

- EAF flow factors
 - EAF CAV factor
- Extra control unit
- Extra sequence Y5
- Heating
 - Exchanger
 - Cooling
 - Pump control
 - Free cooling
 - Support control
 - CO2 / VOC control
 - Fire function
 - Humidity control
 - Exchanger de-icing
 - Cooling recovery
 - Enthalpy control
 - Min. lim. Dampers
 - External setpoint
 - Run ind/Motor prot.
 - Type of actuator
 - Actuator run time
 - Actuat. period time
- Step controllers
 - Step controller heating
 - Step controller cooling

Menu structure

- Recirculation
- Pretreatment
- Alarm settings
- Communication
- Other parameters
 - Delay SAF
 - Delay EAF
 - Retardation time
 - Heating at start-up and high speed blocking
 - Start delay exchanger
 - Exchanger to 100% at start
 - Alarm delay at start
 - Split controller settings
 - Fast stop on alarm “electric heating is overheated”
 - Automatically restart after power on
 - Invert all sum alarm outputs
 - Temperature unit
 - Flow unit
- System
 - Choose Language
 - Choose Start Screen
 - Automatic summer/winter time change over
 - Address ELA, PLA
 - Address for remote communication
 - Time before user is logged off automatically

21 Changing the battery

-  This procedure requires knowledge of proper ESD protection; i.e. an earthed wristband must be used!

When the alarm "Internal Battery" is activated and the battery LED lights up red, the battery for backup of program memory and real-time clock has become too weak. The battery is replaced as described below. A backup capacitor saves the memory and keeps the clock running for at least 10 minutes after the power supply is removed. Therefore, if the battery replacement takes less than 10 minutes, there will be no need to reload the program, and the clock will continue to run normally.

The replacement battery must be of the type CR2032.

Remove the cover by pressing down the locking torques at the edge of the cover using a small screwdriver, and at the same time pulling the edges outwards.

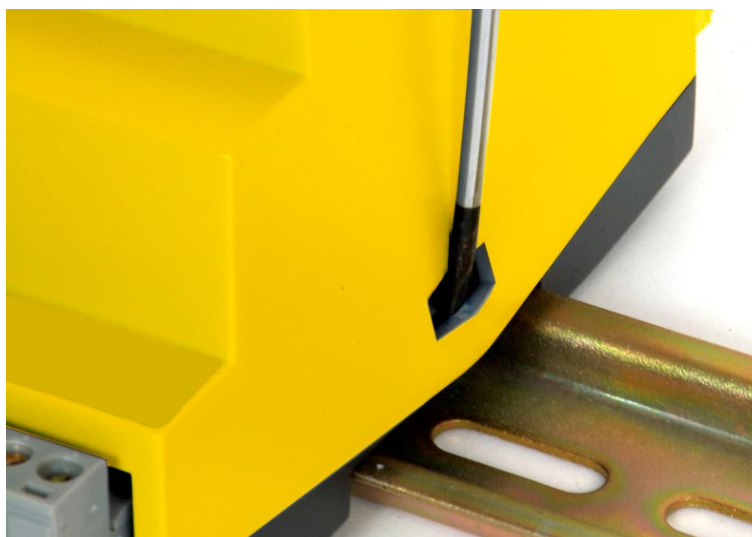

Changing the battery

Battery location

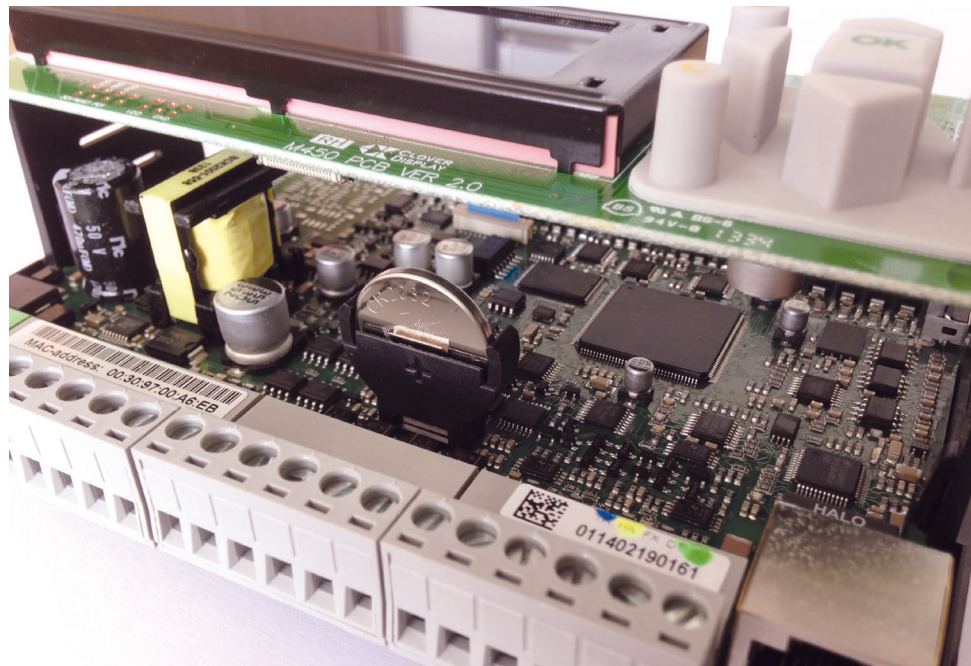

Grip the battery firmly with your fingers and lift it upwards until it rises from its holder.

Press the new battery firmly down into place.

i To preserve correct polarity, the battery can only be inserted the “right way round”!

21.1 Start-up wizard

The start-up wizard is a function that can be activated in „Configuration“/“System“. See section 18.31.7 *Activation of start-up wizard*.

If the wizard has been activated, the operator will access a number of menus at power-up. These menus contain certain operation parameters that should be set.

The wizard is useful when the controller is delivered pre-configured together with an air handling unit. After the controller has been configured, the manufacturer of the air handling unit will activate the start-up wizard, which will help the operator to set setpoint values, running times etc. without having to log on.

In the first menu, the language is chosen.

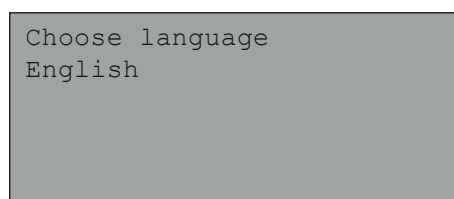

In the second menu, the setpoint is set. The appearance of the menu depends on which control type has been configured.

```
Supply air temp  
Setp.: 18°C
```

In the third menu, time and date are set.

```
Time: 14:27  
Date: 2014-04-16  
Weekday: Tuesday
```

In the fourth menu, the running time for normal speed Monday – Friday is set.

```
Normal speed  
Monday → Friday  
Per 1: 07:00 - 16:00  
Per2: 00:00 - 00:00
```

In the fifth menu, the running time for normal speed Saturday, Sunday and holiday is set.

```
Normal speed  
Saturday → Holiday  
Per 1: 00:00 - 00:00  
Per2: 00:00 - 00:00
```

If 2-speed fans or pressure/flow controlled fans have been configured, the corresponding times for reduced speed will be displayed in the sixth and seventh menus.

```
Reduced speed  
Monday → Friday  
Per 1: 07:00 - 16:00  
Per2: 00:00 - 00:00
```

```
Reduced speed  
Saturday → Holiday  
Per 1: 00:00 - 00:00  
Per2: 00:00 - 00:00
```

Changing the battery

The last menu is used to turn off the wizard, and the flexotron800 will switch to normal running mode. The selected values will be used.

The wizard will not be shown again during further use.

21.2 Energy calculation

The total energy consumption of the air handling unit can be obtained by internally calculating the various partial outputs of system components. By combining the various outputs of heaters/coolers, fans, etc., current power consumption is calculated based on their combined output.

21.3 SFP (Specific Fan Power)

If fans are used that are controlled by frequency converters connected via Modbus and which also supply information on motor output, the flexotron800 is capable of calculating SFP using the following formula:

```
SFP = Total effect from both fans / Supply air fan flow
in kW / (m3/s).
```

“Extra pressure transmitter supply air” is always used to measure flow, if connected. Otherwise “SAF Pressure” will be used or, alternatively, “SAF Pressure 2” if fan control is “Frequency control SAF with EAF flow control”.

Power loss as a percentage of the frequency converter can be added for calculating the total output. If, for instance, power loss is 5%, the total output will be as follows:

```
Total output = (Supply air fan output + Extract air fan
output) x 1.05.
```

A daily and a monthly average (always 30 days) are also computed and presented in the display and in CASE flexotron. SFP for the average values is calculated only when the unit is running.

The display image is located under the menu **Running mode** → **Running mode unit**:

```
SFP: 0.0 kW/m3/s
Day: 0.0 kW/m3/s
Month: 0.0 kW/m3/s
Frequ.loss: 0 %
```

22 Appendix

22.1 Frequency converters

Version 3.3 of flexotron800 ventilation supports the frequency converters listed below:

- Vacon NXL
- Lenze
- Omron V1000
- Emerson Commander
- LS
- EBM
- Danfoss FC 101

When communicating via frequency converters through Modbus, it is sometimes necessary to change certain settings in the frequency converter. Below are described what settings are necessary in the various models:

Vacon NXL

No settings necessary.

Lenze

No settings necessary.

Omron V1000

Connected via RS485:

- R+ is connected to S+
- R- is connected to S-
- R+/S+ is connected to B on port 1 or 2
- R-/S- is connected to A on port 1 or 2

Parameters

The following parameters must be set from the display of the frequency converter:

- H5-01 (0x425): Slave address, set to = 1 for Supply air fan and = 2 for Exhaust air fan
- H5-07 (0x42B): RTS Control, set to = 1 (enabled) for activation of RS485
- o1-03 (0x502): Frequency reference units, set to = 1 for 0–100%.
- H5-03 (0x427): Parity, set to = 0 (no parity)

Default values should be used for remaining parameters. The following values may not be changed:

- H5-02 (0x426): Communication speed, default =3 (9600)
- H5-04 (0x428): Stopping method after communication error, default = 3 (no stop)
- H5-11 (0x43C): Communication Enter Function, default=1 (Enter command not necessary)

Appendix

- H5-12 (0x43D): Run command, default=0 (bit 0=forward start/stop, bit 1=reverse start/stop)
- b1-01 (0x180): Frequency Reference selection 1, default = 2 (via Modbus)
- b2-01 (0x181): Run command selection 1, default = 2 (via Modbus)

Emerson Commander

Connections RS485-RJ45:

- RJ45:2 (orange) is connected to B on port 1 or 2
- RJ45:7 (white/brown) is connected to A on port 1 or 2
- Eventual termination resistor is connected between RJ45:1 (white/orange) and RJ45:8 (brown).

If Modbus communication is not initialised after powering up, disconnect the termination resistor and try again.

Terminals

- Connect terminal B4 (Drive enabled) to B2 (+24V)
- Connect terminal B5 (Forward) to B2 (+24V)

Parameters

The following parameters must be set from the display of the frequency converter:

- 44: Slave address, set to = 1 (default) for Supply air fan and = 2 for Exhaust air fan
- 43: Baud rate: 9.6 (default: 19.2)
- Default values should be used for remaining parameters.

Changing parameters

- Deactivate the unit. The display should read "iH 0.0". This is performed by opening terminal B4.
- Set parameter 10 to "L3", i.e. all parameters up to and including 95 can then be altered.
- Set parameter 43 to 9.6 (9600 baud).

LS

LS frequency converters are controlled via Modbus. Communication, alarms and certain indications can be read:

Address	Modbus register	Name	Scaling	Type
27	30027,40027	FB Status word	-	Binary
511	30511,40511	Cumulative output	0.1	kWh
527	30527,40527	Motor frequency	0.1	+/- Hz
508	30508,40508	Motor current	0.1	A
510	30510,40510	Motor output	0.01	kW
505	30505,40505	DC voltage	1	V
30	30030,40030	Active error	-	Error code

The following parameters are used to control fan speed:

Address	Modbus register	Name	Scaling	Type
1	30001,30001	FB Status word	-	Binary
44	30044,40044	FB Setpoint speed	0.1	Hz
48	30048,40048	Password	-	Binary
49	30049,40049	Password	-	Binary

EBM

EBM frequency converters are controlled via Modbus. Communication, alarms and certain indications can be read.

The following signals can be read from the frequency converter:

Address	Modbus register	Name	Scaling	Type
27	30027,40027	FB Status word	-	Binary
511	30511,40511	Cumulative output	0.1	kWh
527	30527,40527	Motor frequency	0.1	+/- Hz
508	30508,40508	Motor current	0.1	A
510	30510,40510	Motor output	0.01	kW
505	30505,40505	DC voltage	1	V
30	30030,40030	Active error	-	Error code

The following signals can be used to control fan speed:

Address	Modbus register	Name	Scaling	Type
1	30001,30001	Control Word	-	Binary
44	30044,40044	FB Setpoint speed	0.1	Hz
48	30048,40048	Password	-	Binary
49	30049,40049	Password	-	Binary

Danfoss FC 101

Danfoss frequency converters are controlled via Modbus. Communication, alarms and certain indications can be read.

The following signals can be read from the frequency converter:

Address	Modbus register	Name	Scaling	Type
27	30027,40027	FB Status word	-	Binary
511	30511,40511	Cumulative output	0.1	kWh
527	30527,40527	Motor frequency	0.1	+/- Hz
508	30508,40508	Motor current	0.1	A
510	30510,40510	Motor output	0.01	kW
505	30505,40505	DC voltage	1	V
30	30030,40030	Active error	-	Error code

Appendix

The following signals can be used to control fan speed:

Address	Modbus register	Name	Scaling	Type
1	30001,30001	Control Word	-	Binary
44	30044,40044	FB Setpoint speed	0.1	Hz
48	30048,40048	Password	-	Binary
49	30049,40049	Password	-	Binary

© Fr. Sauter AG
Im Surinam 55
CH-4016 Basel
Tel. +41 61 - 695 55 55
Fax +41 61 - 695 55 10
www.sauter-controls.com
info@sauter-controls.com

Printed in Switzerland