



SAUTER flexotron800 V2 Ventilation user program

User guide

P100013560

Contents

1	About this user guide	5
1.1	Disclaimer	5
1.2	Trademark	6
1.3	Safety information	6
1.3.1	Compulsory note	6
1.3.2	General note	6
1.4	Information on using the user guide	7
1.4.1	Mark-ups	7
1.4.2	Activity instructions	7
2	Regarding the flexotron800	9
2.1	Ventilation control: Summary of functions	9
3	Display, buttons and LEDs	13
3.1	Display	13
3.2	Buttons and LEDs	14
4	The menu system	15
4.1	Menu navigation	15
4.1.1	Editing parameters	16
4.2	Operating mode	17
4.2.1	Operating mode of controller	17
4.2.2	Selected functions	18
4.2.3	Alarms	19
4.2.4	Inputs/outputs	19
4.3	Temperature	20
4.3.1	Setpoint for supply air control	20
4.3.2	Setpoint for supply air control based on outside temperature	21
4.3.3	Setpoint for room supply air cascade	22
4.3.4	Setpoint for return air/supply air cascade	22
4.3.5	Setpoint for room-temperature/return-air control compensated for outside temperature	23
4.3.6	Back-up mode for heating/back-up mode for cooling	23
4.3.7	Frost-protection temperature	24
4.3.8	De-icing of the heat recovery	24
4.3.9	Efficiency monitoring for the heat recovery	24
4.3.10	Recirculated air control	25
4.3.11	Additional control loop	26
4.3.12	Enthalpy control	26
4.4	Air control	27
4.4.1	SAF pressure control	27
4.4.2	SAF volume flow control	28
4.4.3	Manual mode for SAF frequency control	29
4.4.4	External frequency control	30
4.4.5	SAF frequency control with EAF slave/volume flow control	31
4.4.6	CO ₂ /VOC	32

Contents

4.5	Humidity control	32
4.5.1	Room humidity sensor	32
4.5.2	Duct humidity sensor	32
4.6	Timer	33
4.6.1	General information	33
4.6.2	Time/Date	33
4.6.3	Timer output, speed 2	34
4.6.4	Timer output, speed 1	34
4.6.5	Follow-up	35
4.6.6	Timer outputs 1...5	35
4.6.7	Holidays	35
4.7	Access rights	36
4.7.1	Log in	36
4.7.2	Log off	37
4.7.3	Automatic logout	37
4.7.4	Change code	37
5	Other functions	39
5.1	Alarm handling	39
5.2	Individual text field	40
5.3	Version number	40
5.4	Language	40
5.5	Indicator LEDs	41
5.5.1	Status indicator	41
5.6	Changing the battery	41
5.7	Start assistant	41
5.8	Basic configuration for ventilation	43
5.8.1	RDT808 – supply air constant control	43
5.8.2	RDT815 – supply air constant control	45
5.8.3	RDT815 – Cascade control	47
5.8.4	RDT828 – Cascade control with CO ₂ control	49
5.8.5	RDT828 – Cascade control with humidity control	52

1 About this user guide

This user guide covers all the models in the flexotron800 series used for ventilation control. The functions described here are for users with the Operator access level or lower.

Revision A, August 2014

Software version: 3.3



More information on the flexotron800 can be found in the following documents:

flexotron800 ventilation user manual – complete user manual for configuring and operating the flexotron800 ventilation controller, available in English, German and French.

CASE flexotron user manual – user manual for configuring the controllers using the CASE flexotron PC software, available in English, German and French.

Network variables – list of variables for Modbus and BACnet communication, available in English.

CE declaration of conformity, flexotron800



This information can be downloaded from <http://www.sauter-controls.com/de>.

1.1 Disclaimer

The information in this user manual has been carefully checked and judged to be correct. Fr. Sauter AG makes no guarantee regarding the content of this manual and requests the reader to report any errors, inaccuracies or unclear formulations so that they can be corrected. The information in this document is subject to change without notice.

No part of this document may be reproduced or passed on to third parties in any form or fashion without the permission of Fr. Sauter AG.

About this user guide

1.2 Trademark

flexotron is a registered trademark of Fr. Sauter AG.

Windows, Windows 2000, Windows XP and Windows Server 2003 are registered trademarks of the Microsoft Corporation.

Some product names mentioned in this document are used for identification purposes only and are the registered trademarks of their respective companies.

1.3 Safety information

1.3.1 Compulsory note

A compulsory note contains important information that must be considered. It can contain the following:

- A regulation
- Important information



A compulsory note appears after this symbol. If it is not adhered to, serious errors can occur in the software.

1.3.2 General note

A general note is information that aids understanding and can contain the following:

- Background information
- A particular scenario



A general note could appear here.

1.4 Information on using the user guide

1.4.1 Mark-ups

Syntax	Use	Action
[SHIFT]	Press key	Press the “Shift” key once
[SHIFT] + [SELECT]	Key combination pressed simultaneously	Press the “Shift” and “Select” keys simultaneously
[SHIFT] [SELECT]	Press key sequence	First press the “Shift” key, then the “Select” key
<i>Operation</i>	Cross-reference, name of chapter	See chapter <i>Operation</i>

1.4.2 Activity instructions

Activity instructions describe work steps that are to be carried out in sequence.

Prerequisite:

Informs the target group about prerequisites that must be fulfilled before the actual activity is carried out.

1. First step
2. Second step
 - ➔ Intermediate result
3. Third step
4. Last step
 - ➔ Final result of activity

2 Regarding the flexotron800

The flexotron800 devices comprise a series of pre-programmed, configurable controllers for various applications.

The flexotron800 series is available in three model sizes, with 8, 15 or 28 inputs/outputs.

The controllers are available with or without a display and buttons. For all controllers, an external display with buttons (RDB800) can be connected.

All the standard functions can be carried out using the display and buttons, or with the CASE flexotron configuration tool. CASE flexotron is installed on a computer and connected via a cable to the controller.



2.1 Ventilation control: Summary of functions

The controller has programs for ventilation control. The temperature controller is based on a supply air PI-controller for ventilation control with pre-programmed control functions. Various control functions and analogue and digital input and output functions can be activated in this controller. Certain functions are mandatory, while others can be selected as options. This means that the display varies according to the model and the selected functions.

Changes to functions cannot be made with the Operator access level described in this manual, but only by users with administrator rights. Also, this should only be done by trained staff. The same goes for all other configurations.

Regarding the flexotron800

The following functions are among those included in the ventilation control:

Various temperature control functions

- Constant supply air temperature control
- Supply air temperature control based on outside temperature
- Room supply air cascade
- Return air/supply air cascade
- Switching between supply air temperature control and room supply air cascade based on outside temperature
- Switching between supply air/return air cascade based on outside temperature
- Room supply air cascade based on outside temperature
- Return air/supply air cascade based on outside temperature
- Additional separate temperature control circuit for, e.g. reheaters.

With control of:

- Heat recovery (circuit compound system, plate or rotation heat exchanger) or mixed air dampers
- Heating coil: Water with frost protection monitoring or electrical with over-temperature monitoring
- Cooler: Water or DX with up to three speeds
- Heater pump, cooler pump, circuit compound system pump

Fan control

- One- or two-speed supply air and return air fans
- Frequency-controlled supply air and return air fans with pressure and volume flow control, manual control or external control via VAV system
- Pressure-controlled supply air fans with slave-connected return air fan (based on output or flow), or conversely with controlled return air fan with slave-connected supply air fan.

Humidity control

Humidification or dehumidification or both are possible.

Timer outputs

For switching the system on and off. Up to five timer outputs for controlling external functions such as lighting, closing doors, etc.

Demand-led ventilation

In buildings with varying usage, the fan speeds or the mixed air dampers can be activated using the measured values of a CO₂/VOC sensor.

Back-up mode

When using the room supply air cascade or return air/supply air cascade control functions, you can use the heating back-up mode and/or cooling back-up mode functions.

Free night cooling

This function is used in the summer to cool the building by using the cold night air in order to reduce the operation of the cooler during the day.

Enthalpy control

This function is used to measure and compare the energy content (enthalpy) of the outside air and the inside air (temperature and air humidity). If the function is activated, the mixed air damper signal for increasing the recirculated air proportion is deactivated if the enthalpy value of the outside air is above the enthalpy value of the inside air.

Pretreatment (type: Puit Canadien)

Damper and pump control for pre-heating or pre-cooling the fresh air via an underground intake duct.

Cold recovery

If the return air temperature is lower than the outside temperature and there is a cooling requirement, the heat recovery signal is inverted and cooled with the cooler return air.

Recirculated air control

Function for distributing the room air using the supply air fan, with or without temperature control.

Staged temperature control for heating/cooling

As an alternative to the analogue "Heating actuator Y1" or "Cooling actuator Y3" temperature control, the heater or cooler can also be activated in stages.

3 Display, buttons and LEDs

This chapter applies to flexotron800 controllers with display and buttons, as well as to RDB800 external displays, which can be connected to flexotron800 units without display and buttons.



3.1 Display

The display has four rows of 20 characters and is backlit. The lighting is normally off. The lighting is activated when the buttons are pressed, and is switched off again after a certain period with no activity.

```
Regulator vent. sys
2008-11-20 13:30
System: Running
Sp: 18.0 Act: 18.2°C
```

Display, buttons and LEDs

3.2 Buttons and LEDs



ARROW up [Up button]:
Scroll up the menu.
(Increase parameter value)



ARROW down [Down button]:
Scroll down the menu.
(Decrease parameter value)



ARROW right [Right button]:
Open submenu.
(Set cursor to the right of the parameter)



ARROW left [Left button]:
Quit submenu.
(Set cursor to the left of the parameter)



OK:
Opens/activates the selected menu or setting.
(Confirms a parameter value)



Alarm:
List of alarms.



Correction:
Reset or cancel a change to parameter values if it has not been confirmed with [OK].



Alarm LED:
The alarm indicator flashes red for unacknowledged alarms. The alarm indicator lights up constantly for alarms that have been acknowledged but not reset.



Input LED:
Some menus have adjustable values. These are indicated by the flashing yellow LED. The value can be changed by pressing the [OK] button.

4 The menu system

4.1 Menu navigation

Depending on the user/access level, the corresponding menu is displayed.

```
Regulator vent. sys  
2013-01-20 13:30  
System: Running  
Sp: 18.0 Act: 18.2°C
```

The start menu is on the basic level of the menu tree. The appearance of the start menu depends on the settings in the configuration (five different variants). The text in the first line can also be changed with CASE flexotron.

The abbreviations Sp and Act stand for the setpoint and actual value of the supply air controller. The same goes for the room supply air cascade or the return air/supply air cascade.

Actual value = the currently measured temperature.

Setpoint = the desired/set temperature.

Press the [Down button] to go through the menus to the lowest level. Press the [Up button] to go back up.

Depending on your access level, various menus are displayed (see the “Access levels” section for more information on logging into a higher access level).

On the basic level, which is displayed without a user logging in, a limited number of menus and submenus are displayed:

Operating mode

Under “Operating mode” the operating mode of the controller can be viewed and adjusted, and selected control functions and alarms can also be displayed.

Temperature, air and humidity control

Actual values and setpoints are shown here. Setpoints can only be changed with Operator, Service or Admin access level.

Time settings

The time, date and set periods of use are shown here. Values can only be changed with Operator, Service or Admin access level.

Access rights

In this menu, you can switch to a higher access level and change the password, or log out of the current access level and continue on the basic level.

The menu system

```
Running mode
Temperature
Air control
Humidity control
Time settings
Access rights
```

A limited menu selection is shown for users with access rights for the basic level. The operating mode of the device can be changed and alarms can be acknowledged.

An Operator can access additional information and change parameters such as setpoints and time settings.

Use the [Up] and [Down] buttons to enter a higher menu level by moving the cursor to the desired position. Press the [Right] button to confirm. If the user has the relevant access rights, the display shows the selected menu.

On each level there may be more new menus, which you can view using the [Up] and [Down] buttons.

Sometimes there are further submenus linked to a menu or menu item. Additional menus are indicated by an arrow symbol in the right corner of the display. Use the [Right] button again to go to these menus.

Press the [Left] button to return to the previous menu.

4.1.1 Editing parameters

You can edit parameters in some menus. This option is indicated by the flashing

yellow LED   .

If the LED flashes rapidly (twice per second), the parameters can be edited using the current access level.

If the LED flashes more slowly (once per second), a higher access level is required to edit the parameters.

To edit a parameter, first press the [OK] button. If you need a higher access level to edit the parameters, a corresponding login menu appears (see below). Otherwise, the cursor appears next to the editable values. Press the [Up] and [Down] buttons to edit the values.

In numbers containing several digits you can move between the digits using the [Left] and [Right] buttons.

When the required value is displayed, press [OK] to confirm it.

If there are other editable values, the cursor automatically moves to the next one.

To skip a value without editing it, press the [Right button].

To reverse a change, press and hold the [C] button until the cursor disappears.

The following section contains a number of menus which display the operating mode, selected functions, alarms and the status of the inputs and outputs.

4.2 Operating mode

```
Running mode
Selected functions
Alarm events
Input/Output
```

4.2.1 Operating mode of controller

The operating mode of the controller can be changed without logging in.

```
Running mode
Auto
```

The operating mode can be set to **AUTO**, **OFF**, **MANUAL OPERATION LEVEL 1** or **MANUAL OPERATION LEVEL 2**. Normally, the **AUTO mode** should be used. **OFF** can be used to stop the system for servicing, etc.

With **MANUAL OPERATION LEVEL 1** or **MANUAL OPERATION LEVEL 2**, the system starts even if the timer output sets the operating mode to **OFF**.

In operating mode **OFF**, **MANUAL OPERATION LEVEL 1** or **MANUAL OPERATION LEVEL 2**, a **C alarm** is triggered:

MANUAL operating mode. The alarm is automatically reset if the operating mode is set to **AUTO** again.

```
Op time
SAF: 14.6 h
```

Shows the total running time of the fans.

The menu system

4.2.2 Selected functions

In these menus, the settings for the most important functions are displayed. They cannot be changed.

```
Control function
Supply air control
Fan control
1-speed
```

Heaters, heat recovery and coolers. If a function is not being used, "Not used" is displayed.

```
Heating: Water
Exchanger: Plate exc
Cooling: Water
```

This function is used in the summer to cool the building using the cold night air, in order to reduce the cooling requirement during the day and also the energy consumption.

```
Free cool active: No
```

The back-up mode is used to adjust the room temperature outside the usage period. If the temperature in the room decreases or increases, the system is switched on and the temperature is controlled.

```
Support control
Active: Yes
CO2/VOC active
If time channel on
```

This function defines the settings for the fire protection dampers and the operating mode of the system in the case of a fire alarm.

```
Fire damper function
Not active
Operation when alarm
Stopped
```

When the heating is being used, the frost-protection facility should always be activated. With cold recovery, in contrast to the heat recovery, the cold return air is used for the cooling if it is below the outside temperature and there is a cooling requirement.

```
Frost protection
Active
Cooling recovery
Not active
```

An analogue input can be configured for an external setpoint transmitter.

```
External setpoint
Not active
```

4.2.3 Alarms

List of the last 40 alarms. The most recent alarms are displayed first and provide an overview of the alarms that are occurring. Alarms are described in detail in the “Alarm handling” section.

```
24 Nov 14:32   B
Malf. SAF

Acknowledged
```

4.2.4 Inputs/outputs

This menu shows the current values for all the configured inputs and outputs. These cannot be changed. Universal inputs can be configured as analogue or digital inputs.

```
AI
DI
UI
AO
DO
```

Analogue inputs and digital outputs are shown here as examples.

The menu system

Analogue inputs/outputs

The current values for the analogue inputs and outputs are displayed here.

```
AI1: 18.5 Outdoortemp
AI2: 20.3 Supplytemp
AI3: 28.2 Frost.temp
AI4: 19.9 Room1.temp
```

Digital inputs/outputs

This menu shows whether digital inputs and outputs are activated or deactivated.

```
DO1:Off SAF 1/1-speed
DO2:Off EAF 1/1-speed
DO3: On SAF 1/2-speed
DO4:Off EAF 1/2-speed
```

4.3 Temperature

All the actual values and setpoints for the temperature control are displayed here. The menu is visible for all users, no matter what access rights they have. To be able to make changes, the user must have at least Operator access rights.

Only the menus for activated functions are displayed.

4.3.1 Setpoint for supply air control

Setpoint for supply air control. Actual values and setpoints, as well as the outside temperature, are displayed here (if an outside-temperature sensor is set up). No settings can be made in this menu.

```
Outdoortemp.:18.4°C
Supply air temp
Act.: 19.8°C Setp->
Setp.: 20.0°C
```

Submenu: Setpoint.

```
Supply air temp
Setp.: 20.0°C
```

4.3.2 Setpoint for supply air control based on outside temperature

Setpoint for supply air control based on outside temperature. Actual values and setpoints, as well as the outside temperature, are displayed here (if an outside-temperature sensor is set up). No settings can be made in this menu.

```
Outdoor temp.:18.4°C
Supply air temp
Actual: 19.8°C Setp->
Setp.: 20.0°C
```

Submenus: Setpoint

In the room supply air cascade and return air/supply air cascade control modes, the control curve is used when the supply air control is active.

```
Outdoor comp. setp.
-20.0°C = 25.0°C
-15.0°C = 24.0°C
-10.0°C = 23.0°C
```

Eight characteristic points are used to determine the supply air setpoint based on the outside temperature.

```
Outdoor comp. setp.
-5.0°C = 23.0°C
0.0°C = 22.0°C
5.0°C = 20.0°C
```

Intermediate values are determined by means of a linear function that uses the characteristic points.

Setpoints for temperatures that are below the lowest or above the highest characteristic point are determined by extending the straight lines between the respective last two characteristic points.

```
Outdoor comp. setp.
10.0°C = 19.0°C
20.0°C = 18.0°C
```

Example: The lowest characteristic point is $-20.0\text{ °C} = 25\text{ °C}$. For every additional 5 °C step that the outside temperature decreases, the setpoint increases by 1 °C . Thus, the setpoint for -23 °C outside temperature is $25\text{ °C} + 0.6 \times 1.0\text{ °C} = 25.6\text{ °C}$.

The menu system

4.3.3 Setpoint for room supply air cascade

Setpoint for room supply air cascade.

When the room supply air cascade is active, the room setpoint is used as the setpoint for the cascade.

```
Room temp.1
Actual: 22.0°C
Setpoint: 21.5°C    ->
```

Submenu for setting the min. and max. limitation of the supply air temperature.

```
If cascade control
max/min supply setp.
Max: 30.0°C
Min: 12.0°C
```

If two room-temperature controllers are configured, this menu is also displayed. The controller uses the mean temperature of the two sensors.

```
Room temp.2
Actual: 21.8°C
```

4.3.4 Setpoint for return air/supply air cascade

Setpoint for return air/supply air cascade.

When the return air/supply air cascade is active, the return air setpoint is used as the setpoint for the cascade.

```
Extract air temp.
Actual: 21.0°C
Setpoint: 21.1°C
```

Submenu for setting the min. and max. limitation of the supply air temperature.

```
If cascade control
max/min supply setp.
Max: 30.0°C
Min: 12.0°C
```

4.3.5 Setpoint for room-temperature/return-air control compensated for outside temperature

Gives you the option to balance the room temperature/return air temperature with the outside temperature. Note that the curve must be adjusted for optimal operation!

```
Room temp1
Actual: 22.0°C
Setp.: 21.5°C    ->
```

```
Outdoor comp. setp.
-20.0°C = 25.0°C
-15.0°C = 24.0°C
-10.0°C = 23.0°C
```

This function is based on the assumption that a slightly higher inside temperature is acceptable when it is warm outside, and vice versa, since this presents an excellent opportunity for saving energy.

```
Outdoor comp. setp.
-5.0°C = 23.0°C
0.0°C = 22.0°C
5.0°C = 20.0°C
```

```
Outdoor comp. setp.
10.0°C = 19.0°C
20.0°C = 18.0°C
```

```
If cascade control
max/min supply setp.
Max: 30.0°C
Min: 12.0°C
```

4.3.6 Back-up mode for heating/back-up mode for cooling

The back-up mode is normally used when the room supply air cascade and the return air/supply air cascade are used, so that the room temperature does not increase or decrease too much when the unit is not being used.

```
Support heating
Room temp for
Start: 15.0°C
Stop: 21.0°C
```

The menu system

The back-up mode for heating or cooling is effective, if it is set and required, when the unit is not being used (timer OFF) and when the follow-up is not active.

The minimum run time can be set to between 0...720 minutes (factory setting = 20 minutes).

```
Support cooling
Room temp for
Start: 30.0°C
Stop: 28.0°C
```

4.3.7 Frost-protection temperature

Actual value on the frost protection sensor in return.

```
Frost protection
Actual: 30.9°C
```

4.3.8 De-icing of the heat recovery

This menu is displayed when the de-icing function for the heat recovery has been set.

If the temperature on the de-icing sensor falls below the setpoint, the de-icing starts and is automatically ended when the temperature rises above the setpoint plus the set difference.

```
De-icing exchanger
Actual: 11.2°C
Setpoint: -3.0°C
Hysteresis: 1.0°C
```

4.3.9 Efficiency monitoring for the heat recovery

This function calculates the efficiency of the heat recovery in % when the control signal for the heat recovery is above 5% and the outdoor temperature is below 10 °C. The function requires a return air sensor, an exhaust air sensor and an outdoor air sensor. If the control signal is below 5% or the outside temperature is above 10 °C, the display shows 0%.

```
Efficiency exch.
Actual: 93%
Output exchanger
Actual: 100%
```

4.3.10 Recirculated air control

The first of the following three menus is to be found in the controller under “Configuration”. The fourth menu is to be found under “Temperature”.

```
Enable temp control  
when recirculation:  
Heat- and cooling ->
```

The recirculated air control is used to distribute the room air via a supply air fan. This function can be used even if there is no heating or cooling requirement. When the recirculated air control is operating, the return air fan is switched off and the recirculation damper opens so that the air can circulate through the ventilation system.

```
Constant or  
setpoint offset  
when recirculation:  
Constant
```

You can select whether the return air fan is running or not during the recirculated air control.

```
EAF running during  
recirculation: no
```

```
Offset SAF when  
frequency control  
and recirculation:  
0.0 Pa
```

During the recirculated air control, the SAF offset allows you to add an additional offset to the setpoint during normal operation.

If pressure control has been configured, the offset is set in Pa. If volume flow control has been configured, the offset is set in m³/h. If manual control has been configured, the offset is set in %.

If the offset function has been selected (a deviation of the regular supply air setpoint), you have the option to change the offset value here instead.

The menu system

4.3.11 Additional control loop

An independent temperature control loop circuit for controlling reheaters, for example. The control loop can be configured for heating or cooling.

```
Extra control circuit
Actual: 21.2°C
Setpoint: 20.0°C
```

4.3.12 Enthalpy control

This function is used to deactivate the positioning signal of the mixed air damper for increasing the recirculated air proportion if the enthalpy value of the outside air is above the enthalpy value of the inside air.

```
Enthalpy indoor:
35.5 kJ/kg
Enthalpy outdoor:
36.4 kJ/kg
```

Submenu for reading the outside temperature and the outside humidity.

```
Outdoortemp
Act.: 19.2 °C
Humidity outdoor
Act.: 51.1 % RH
```

Submenu for reading the room temperature and the room humidity.

```
Indoortemp
Act.: 19.9°C
Humidity indoor
Act: 44.3 % RH
```

Shows whether the enthalpy control has been activated.

```
Override Cool Reco-
very due to Enthalpy:
Active
```

4.4 Air control

This menu is only shown if frequency-controlled fans have been configured.

Depending on the fan control, different menu combinations are shown.

4.4.1 SAF pressure control

(There are also corresponding menus for EAF)

Setpoint for pressure control. Actual values and setpoints are displayed here. No settings can be made in this menu.

```
Pressure contr. SAF
Actual: 480 Pa
Setp.: 490 Pa      ->
```

Submenu for setpoints for speed 2 (1/1) and speed 1 (1/2).

```
Pressure contr. SAF
Setp 1/1: 490 Pa
Setp 1/2: 300 Pa
```

Submenu for control based on outside temperature. A control of the pressure setpoint based on outside temperature can be added.

The control based on outside temperature can be set either for the supply air fan or for both fans.

```
Outd. comp. setp.
-20 °C = -50 Pa
 10 °C =  0 Pa
Act. Comp: -5 Pa->
```

Submenu for control based on outside temperature. A control based on outside temperature similar to the one already mentioned, but with a selectable temperature sensor.

```
Comp.sens.:Roomtemp1
15 °C = 0 Pa
20 °C = 0 Pa
25 °C = 0 Pa
```

The menu system

4.4.2 SAF volume flow control

(There are also corresponding menus for EAF)

Setpoint for volume flow control. Actual values and setpoints are shown here. No settings can be made in this menu.

```
Flow control SAF
Actual: 1800 m3/h
Setp.: 2000 m3/h    ->
```

Submenu for setpoints for speed 2 (1/1) and speed 1 (1/2).

```
Flow control SAF
Setp 1/1: 2000 m3/h
Setp 1/2: 1000 m3/h
```

Submenu for control based on outside temperature. A control of the pressure setpoint based on outside temperature can be added.

The control based on outside temperature can be set either for the supply air fan or for both fans.

```
Outdoor comp. setp.
-15 °C = -200.0 m3/h
 10 °C =  0.0 m3/h
Act. comp: 0.0 m3/h->
```

Submenu for control based on outside temperature. A control based on outside temperature similar to the one already mentioned, but with a selectable temperature sensor.

```
Comp.sens.:Roomtemp1
15 °C = 0 m3/h
20 °C = 0 m3/h
25 °C = 0 m3/h
```

4.4.3 Manual mode for SAF frequency control

(There are also corresponding menus for EAF)

Current output signal. Actual values and setpoints are displayed. No settings can be made in this menu.

```
Frequency control
manual SAF
Output: 75%      ->
```

Submenu for setpoints for speed 2 (1/1) and speed 1 (1/2).

The setpoint is set as a % of the total output. 100% = 10 V output signal.

```
Frequency control
manual SAF
Output 1/1: 75%
Output 1/2: 50%
```

Submenu for control based on outside temperature. A control of the pressure setpoint based on outside temperature can be added.

The control based on outside temperature can be set either for the supply air fan or for both fans.

```
Outdoor comp. outp.
-20 °C = -40 %
 10 °C = 0 %
Act. Comp: 0 %
```

Submenu for control based on outside temperature. A control based on outside temperature similar to the one already mentioned, but with a selectable temperature sensor.

```
Comp. sens.: Roomtempl
15 °C = 0 %
20 °C = 0 %
25 °C = 0 %
```

The menu system

4.4.4 External frequency control

For fan control that uses an external control signal, e.g. via a VAV optimiser.

```

Frequency Control
manual SAF
Output: 0 %    ->
    
```

```

Outdoor comp.outp.
-20 °C = -40 %
 10 °C = 0 %
Act. comp= 0 % ->
    
```

```

Comp.sens.:Roomtempl
15 °C = 0 %
20 °C = 0 %
25 °C = 0 %
    
```

```

Controller output
comp if cooling
 0 at HCO= 0 %
100 at HCO= 0 %
    
```

```

Controller output
comp if heating
 0 at HCO= 0 %
100 at HCO= 0 %
    
```

```

Controller output
compensation
Not active
    
```

```

Compensation only
when:
1/1-speed: No
defrosting: No
    
```

4.4.5 SAF frequency control with EAF slave/volume flow control



(Also available for the opposite function)

Pressure control that operates either SAF or EAF as a slave. This function is also available with volume flow control.

```
Pressure contr. SAF
Actual: 480 Pa
Setp: 490 Pa  ->
```

```
Pressure contr. SAF
Setp 1/1: 500 Pa
Setp 1/2: 250 Pa
```

```
Outdoor comp.setp.
-20 °C = 0 Pa
 10 °C = 0 Pa
Act. comp= 0 Pa ->
```

```
Comp.sens.:Roomtemp1
15 °C = 0 Pa
20 °C = 0 Pa
25 °C = 0 Pa ->
```

```
Controller output
comp if cooling
  0 at HCO = 0 %
100 at HCO = 0 %
```

```
Controller output
comp if heating
  0 at HCO = 0 %
100 at HCO = 0 %
```

```
Controller output
compensation
Not active
```

The menu system

```
Compensation only  
when:  
1/1-speed: No  
defrosting: No
```

4.4.6 CO2/VOC

In applications with varying room occupancy, the fan speed can be adjusted using the measured values of a CO2/VOC sensor.

```
CO2  
Actual: 920ppm  
Setp.: 1000ppm
```

4.5 Humidity control

This menu is shown if humidity control has been configured.

4.5.1 Room humidity sensor

Humidity control can be configured as only humidification or dehumidification, or as both in combination.

```
Humidity room  
Actual: 51.9% RH  
Setp.: 50.0% RH
```

4.5.2 Duct humidity sensor

A duct humidity sensor is only used for the max. limitation of the supply air humidity.

```
Humidity duct  
Actual: 72.2% RH  
Max.limit: 80.0% RH  
Hyst.: 20.0% RH
```

4.6 Timer

4.6.1 General information

The controller has a calendar programme where weekly schedules and holidays can be set for the whole year.

The switch between summertime and wintertime is performed automatically.

Individual schedules for each day of the week plus a separate holiday schedule. Up to 24 individual holidays/holiday periods can be configured.

A holiday period can be both a single day and up to 365 consecutive days. Holiday schedules take precedence over other schedules.

```
Time/Date
Timer Normal speed
Timer Reduced speed
Extended running
Timer output 1    ->
Timer output 2    ->
Timer output 3    ->
Timer output 4    ->
Timer output 5    ->
Holidays          ->
```

Every day has up to two separate periods of use. For two-speed fans and pressure-controlled fans there are daily individual time programmes for speed 1 and speed 2, each with up to two periods of use.

Digital outputs can be assigned to a maximum of five free timer outputs, each with two periods of use per day (and individual weekly schedules). These outputs can be used to switch the lighting on and off, close doors, etc. (Only configured outputs are displayed.)

4.6.2 Time/Date

This menu shows and allows you to set the controller time and date.

The time is shown in the 24-hour format.

The date is shown as YY:MM:DD.

```
Current time: 18:21
Date: 2013-01-10
Weekday: Wednesday
```

The menu system

4.6.3 Timer output, speed 2

There are eight separate menus, one for each weekday and an additional one for holidays. Holiday schedules have priority over other weekday schedules.

For a running time of 24 hours, a period from 00:00 to 24:00 must be set.

To deactivate a period of use, set the time to 00:00–00:00. If both periods are set to 00:00–00:00, the installation does not run at speed 2 on this day.

```
Normal speed
Monday
Per.1: 07:00 - 16:00
Per.2: 00:00 - 00:00
```

If you want to run the installation on two consecutive days, e.g. from Mon 22:00 to Tue 09:00, the desired running time for both days must be set separately.

First Mon 22:00–24:00...

```
Normal speed
Monday
Per.1: 07:00 - 16:00
Per.2: 22:00 - 24:00
```

... then Tue 00:00–09:00.

```
Normal speed
Tuesday
Per.1: 00:00 - 09:00
Per.2: 00:00 - 00:00
```

4.6.4 Timer output, speed 1

The settings for speed 1 are ignored if settings for speed 2 have been made.

If the periods of use for speed 1 and speed 2 overlap, the settings for speed 2 have priority.

```
Normal speed
Tuesday
Per.1: 00:00 - 09:00
Per.2: 00:00 - 00:00
```

There are eight separate menus, one for each weekday and an additional one for holidays. Holiday schedules take precedence over other schedules. For a running time of 24 hours, a time period from 00:00 to 24:00 must be set. To deactivate a period of use, set the time to 00:00–00:00. If both time periods are set to 00:00–0:00, the installation does not run at speed 1 on this day.

4.6.5 Follow-up

Digital inputs can be used to activate a unit even if the operating mode of the timer should be “OFF”. For 2-speed fans and pressure-/flow-controlled fans, inputs for speeds 1 and 2 can be used.

```
Extended running
60 min
Time in ext. running
0 min
```

The unit is activated for the duration of the set time period. If the running time is set to 0, the unit only runs as long as the digital input is closed.

4.6.6 Timer outputs 1...5

Digital outputs can be assigned to up to five free timer outputs. Only configured outputs are shown, each with individual weekly schedules with two periods of use per day.

```
Timer output 2
Wednesday
Per.1: 05:30 - 08:00
Per.2: 17:00 - 23:00
```

Each timer output has eight different menus, one for each weekday and an additional one for holidays. Holiday schedules have priority over other schedules. If the recirculated air control has been configured, timer output 5 can be used for the start/stop control of this function.

4.6.7 Holidays

Up to 24 separate holiday periods can be set for a full year.

A holiday period can be individual days or any number of consecutive days. The dates are in the format: MM-DD

If the current date falls within a holiday period, the settings for holidays apply.

```
Holidays (mm:dd)
1: 01-01 - 02-01
2: 09-04 - 12-04
3: 01-05 - 01-05
```

The menu system

4.7 Access rights

There are four different access levels: Basic (the lowest level, for which no login is required), Operator, Service and Admin. Admin is the highest level with the most access rights. The access level determines which menus and editable parameters are displayed.

Basic level allows the control mode to be changed and read-only access to a limited number of menus.

Operator level gives access to all menus except "Configuration".

Service level gives access to all menus except the submenus "Configuration"/"Inputs and Outputs" and "Configuration"/"System".

Admin level gives full read/write access to all settings and parameters in all menus.

To log into the various access levels, repeatedly press the [Down] button in the start display until the arrow in the left of the display points to the access rights, then press the [Right] button.

```
Log on
Log off
Change password
```

4.7.1 Log in

In this menu it is possible to log into any access level by entering the appropriate 4-digit password (code). The menu is also displayed if you try to access a menu or carry out a function that requires a higher access level.

```
Log on
Enter password:****
Actual level: None
```

When you press the [OK] button, the cursor jumps to the first digit. Repeatedly press the [Up] button to set the digit. Press the [Right] button to go to the next digit. Repeat the procedure for all four digits of the password. Press [OK] to confirm. An info text about the current access level appears in the display. Use the [Left] button to quit this menu.



The code for the Operator access level is 3333.

4.7.2 Log off

Use this menu to log out from the current access level to the Basic level that does not require a login.

```
Log off?  
No  
Actual level:Admin
```

4.7.3 Automatic logout

If the access level is Operator, Service or Admin, the user is automatically logged out and returned to Basic level after a period of inactivity. The time for this can be set.



4.7.4 Change code

The password can be changed for the current access level or a lower one.

```
Change password for  
level:Operator  
New password: ****
```

5 Other functions

5.1 Alarm handling

If an alarm occurs, the red alarm LED   flashes either on the front panel of controllers with a display or on an external display. The LED flashes as long as there are unacknowledged alarms.

Alarms are logged in the alarm list. The list shows the type of alarm, the date and the time, and the alarm class (A, B or C).

Press the [Alarm] button on the front panel to see the alarm list.

```
Sensor error Supply
Air temp
24 Aug 10:43 Class:B
Reset ▼
```

If there are several alarms, two arrows (up/down) appear on the right of the display. Use the [Up] and [Down] buttons to scroll to the other alarms.

The alarm status is shown in the bottom left of the display. For active, unacknowledged alarms this field is blank. Unacknowledged alarms that have been reset are marked as returned. Acknowledged alarms or alarms that are blocked but still active are indicated as acknowledged or blocked.

In order to acknowledge an alarm, you must first press [OK]. You can then either acknowledge the alarm or block it.

Acknowledged alarms remain on the alarm list until the cause of the alarm has been eliminated.

Blocked alarms remain on the alarm list until the cause of the alarm has been eliminated and the block has been removed. New alarms of the same type will not be activated as long as the block remains.



Because blocking alarms can be potentially hazardous, you need a high user access level to do this.

Class A and B alarms activate alarm outputs if these have been configured.

Class C alarms do not activate the alarm outputs.

Class C alarms are removed from the alarm list when the alarm inputs are reset, even if they are not acknowledged.

Other functions

5.2 Individual text field

If you press the [Right] button in the start menu, a display appears with a text that you can customise.

You can use the text for the name of the installing company, for service contacts and telephone numbers or other information.

The easiest way is to enter the text using CASE flexotron, but you can also use the buttons. Up to four lines, each with 20 characters, can be individually edited.

5.3 Version number

Press the [Right] button twice in the start menu to see the version number of the program and the ID number in the display.

5.4 Language



1. Go to the Start menu.
2. Press the [Right] button three times
 - ➔ The menu for setting the language is displayed
3. Press the [OK] button.
4. Use the [Up] or [Down] button to select the required language.
5. Confirm the selection using the [OK] button.
 - ➔ The selected language is activated.

The various languages are stored in the controller application memory and are loaded to the RAM.

5.5 Indicator LEDs

The status is shown in the upper left corner of the controller. On controllers with a display, the alarm indicator and mode selection LEDs are beside the buttons.

5.5.1 Status indicator

Information	Colour	Description
P1 RxTx	Yellow/green	Interface 1, send/receive
P2 RxTx	Yellow/green	Interface 2, send/receive
TCP/IP (TCP models)	Yellow/green	Green: Connection to other network devices Flashing green: Network data transfer Flashing yellow: For identification
P/B (power supply / battery)	Green/red	Power supply on / battery fault
Controller with built-in display:	-	-
	Red	Alarm display
	Yellow	Input mode

5.6 Changing the battery

The flexotron800 controller has a back-up battery for the memory and real-time clock in the event of a power failure.

If the “internal battery” alarm is triggered and the battery LED lights up red, the battery must be replaced. A back-up capacitor protects the content of the memory for at least 10 minutes without power.



The battery may only be changed by trained staff.

5.7 Start assistant

When the controller is switched on for the first time, it runs through a special procedure: Information on the type, communication settings and software version is displayed.

1. Use the [Down] button to select the Application entry. Press the [Right] button to confirm.
2. Select the application.
 - ▶ flexotron800 Vent. (ventilation application)
 - ▶ flexotron800 Heat. (heating application)
 - ▶ Expansion unit 1
 - ▶ Expansion unit 2
 - ▶ Preloaded vtc-files (prepared configuration files)

Other functions

Use the [Down] button to put the cursor on Preloaded vtc files. Press the [Right] button to confirm.

3. Confirm with [OK] to activate the prepared configuration.
 - ▶ The cursor flashes on Activate: NO
4. Press the [Up] or [Down] button to set the Activate? entry to YES, and confirm with [OK].
5. Select application options using the [OK] and [Down] buttons. The following selection options are available for the ventilation application:

▶ Standard	Factory setting
▶ 808 fixed-value	Fixed-value control for supply air
▶ 815 fixed-value	Fixed-value control for supply air
▶ 815 cascade control	Cascade control for return air/supply air
▶ 828 cascade & CO2	Cascade control for return air/supply air including control of the CO2 content using VFD
▶ 828 cascade & humidity	Cascade control for return air/supply air with additional humidity control

The number at the start of the selection corresponds to the numbers in the item number of the device.



Selecting an application that is unsuitable for the device may result in undefined operating statuses for the inputs and outputs.

6. Select the application using the [OK] button.
 - ➔ The cursor jumps to “Accept changes: No”.
7. Then press the [Up] or [Down] button until the display changes to Yes. Press [OK] to confirm.
 - ➔ The program loads and the default display appears.
 - ➔ The controller switches to normal operation.



This procedure does not appear any more after a restart.

8. Select the language. To do this, press the [Right] button three times in the basic display, then press [OK] and use the [Up] or [Down] button to select the preferred language. Then confirm with [OK].

5.8 Basic configuration for ventilation

In the start assistant (see previous section), each type of device features a choice of one or two configurations. These configurations can be applied without changes, or can be used as a starting point for individual customisations.

5.8.1 RDT808 – supply air constant control

Structure of installation:

- Outside- and exhaust-air dampers
- Air filter
- One-speed fans
- Heating coil with pump, regulating valve, frost monitor
- Supply air sensor
- Outside sensor

Closed-loop control functions:

- Temperature control for constant supply air

Open-loop control functions:

- Start-up circuit
- Frost monitor for heater
- Min./max. limit for inlet temperature
- Motor/air flow monitor
- Pump anti-jamming function
- Standstill control

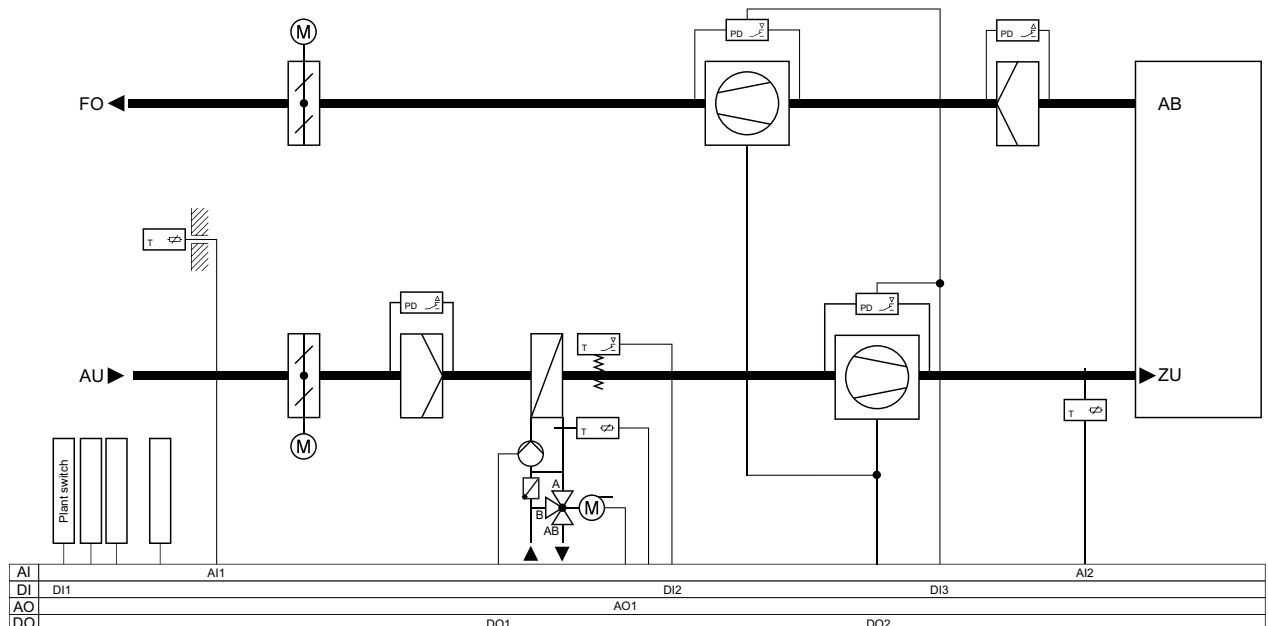

Brief description:



The outside air and exhaust air dampers are closed when the installation is switched off. Operation of the installation is enabled using a switch, and the installation is run in automatic mode using the time programme.

Other functions

If a fault is indicated in the air flow or supply air sensor, the installation is switched off. If the unit is operating fault-free, the temperature control system adjusts the setpoint to the one entered in the display using the heating coil.

The start-up circuit reduces the risk of faults due to frost when outside temperatures are very low.

Terminal assignment:

	LS	Power supply 24 V AC or 24 V DC, ±15%. 50/60 Hz	1	D+	RS485 Modbus (not with WEB (TCP/IP) models)
	MM		2	D-	
		Earth conductor	3	C	
43	+24V	+24 V DC. Reference point for digital inputs DI	4	E	
42	LS	Reference point for digital outputs DO			
41	DO1	Heating coil pump			
40	DO2	Supply air fan			
34		Reference potential for analogue inputs AI	9	DI1	External OFF switch
33	AI1	Outside-temperature sensor	10	DI2	Frost-protection function
32	AI2	Sensor for supply air temperature	11	DI3	Supply air fan on
17		Reference potential for analogue outputs AO			
18	AO1	Actuator for heater Y1			

5.8.2 RDT815 – supply air constant control

Structure of installation:

- Energy recovery using plate heat exchanger
- Two-speed fans
- Heating coil with pump, regulating valve, frost monitor, return sensor
- Air cooler with regulating valve
- Supply air sensor
- Outside sensor
- Air filter

Closed-loop control functions:

- Temperature control for constant supply air

Open-loop control functions:

- Start-up circuit
- Frost monitor for heater
- Motor/air flow monitor
- Icing monitor for heat exchanger
- Pump anti-jamming function
- Collective alarm
- Standstill control

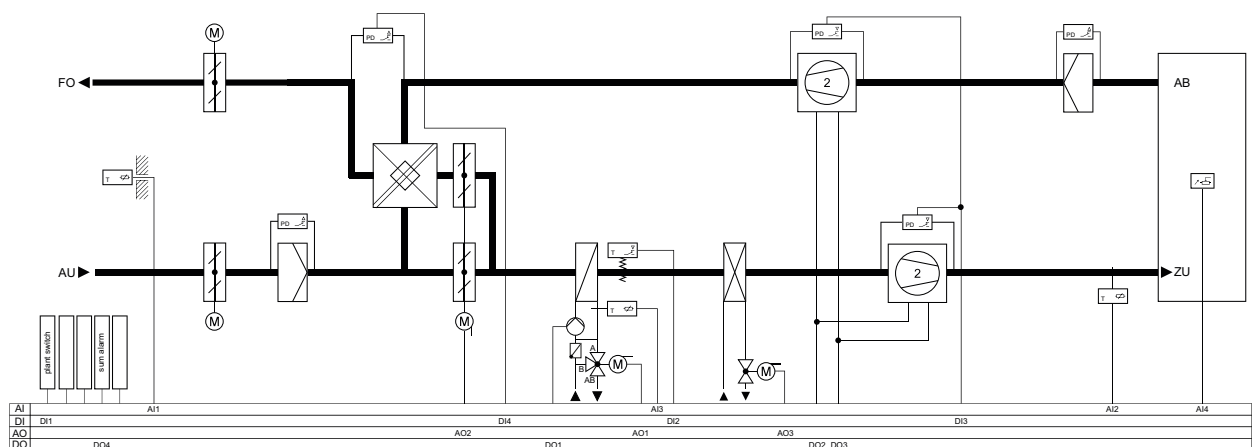

Brief description:

The outside air and exhaust air dampers, along with the HRec bypass valve, are closed when the installation is switched off. The installation can be switched on or off in automatic mode using a time programme or free outside air cooling.

If a fault is indicated for the motor/air flow, the sensor or the frost-protection function, the installation is switched off. A collective alarm can be indicated externally. The monitor for differential pressure on the exhaust air side protects the HRec plate coil from excessive icing. If the installation is running properly, the temperature control system corrects the variable setpoint via the heating coil, the HRec and the air cooler.

Other functions



The heater start-up circuit reduces the risk of frost faults when outside temperatures are very low. The standstill control system protects the heating coil in areas not protected from frost.

Terminal assignment:

	LS	Power supply 24 V AC or 24 V DC, ±15%. 50/60 Hz
	MM	
		Earth conductor
43	+24V	+24 V DC. Reference point for digital inputs DI

1	D+	RS485 Modbus (not with WEB (TCP/IP) models)
2	D-	
3	C	
4	E	

42	LS	Reference point for digital outputs DO
41	DO1	Heating coil pump
40	DO2	Supply air fan, level 1
39	DO3	Supply air fan, level 2
38	DO4	Collective alarm

34		Reference potential for analogue inputs AI
33	AI1	Outside-temperature sensor
32	AI2	Sensor for supply air temperature
31		Reference potential for analogue inputs AI
30	AI3	Frost-protection sensor
29	AI4	Setpoint for room temperature

9	DI1	External OFF switch
10	DI2	Frost-protection function
11	DI3	Supply air fan on
12	DI4	Anti-icing function

17		Reference potential for analogue outputs AO
18	AO1	Y1 actuator for heater
19	AO2	Y2 actuator for HRec
20	AO3	Y3 actuator for cooler

5.8.3 RDT815 – Cascade control

Structure of installation:

- Energy recovery using plate heat exchanger
- 2-speed fans
- Heating coil with pump, regulating valve, frost monitor, return sensor
- Air cooler with regulating valve
- Supply air sensor
- Outside and return air sensors
- Air filter

Closed-loop control functions:

- Temperature control using return air/supply air cascade

Open-loop control functions:

- Start-up circuit
- Free outside air cooling
- Frost monitor
- Sensor monitoring
- Min./max. limit for supply air temperature
- Motor/air flow monitor
- Pump anti-jamming function
- Collective alarm
- Standstill control

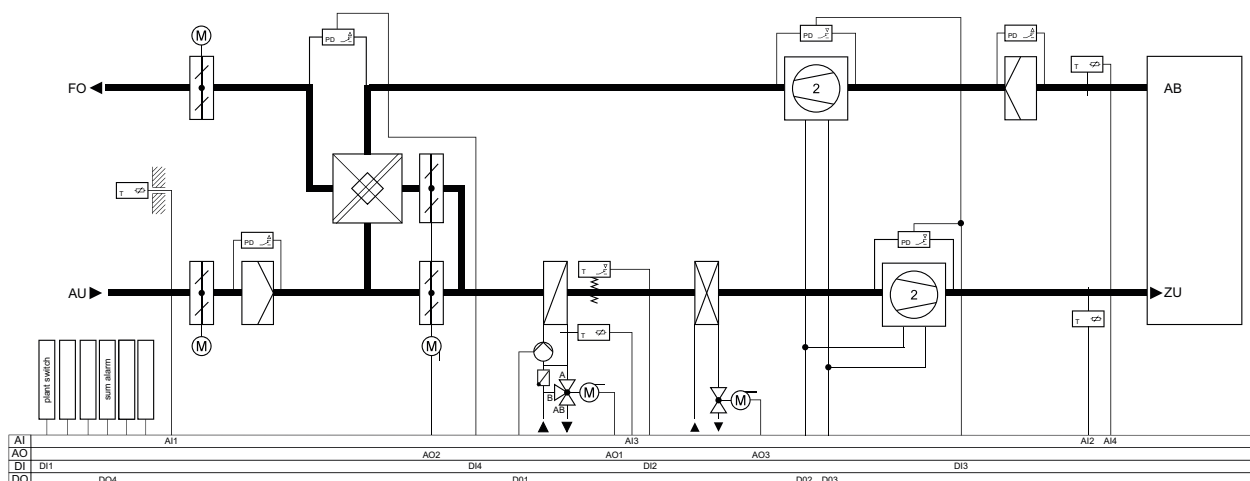

Brief description:

The outside air and exhaust air dampers, along with the HRec bypass valve, are closed when the installation is switched off. The installation can be switched on or off in automatic mode using a time programme or free outside air cooling. If a fault is indicated for the motor/air flow, the frost-protection facility or the supply air sensor, the installation is switched off. A collective alarm can be indicated externally. The monitor for differential pressure on the exhaust air side protects the HRec plate coil from excessive icing.

Other functions



If the installation is running properly, the return air/supply air cascade temperature control corrects the variable setpoint via the heating coil, the HRec and the air cooler. If a wire breaks or there is a short circuit in the return air sensor, the sensor monitor is activated. The minimum and maximum supply air temperature is then limited. The start-up circuit reduces the risk of faults due to frost when outside temperatures are very low. The standstill control system protects the heating coil in areas not protected from frost.

Terminal assignment:

	LS	Power supply 24 V AC or 24 V DC, ±15%. 50/60 Hz
	MM	
		Earth conductor
43	+24V	+24 V DC. Reference point for digital inputs DI

1	D+	RS485 Modbus (not for WEB (TCP/IP) models)
2	D-	
3	C	
4	E	

42	LS	Reference point for digital outputs DO
41	DO1	Heating coil pump
40	DO2	Supply air fan, level 1
39	DO3	Supply air fan, level 2
38	DO4	Collective alarm

34		Reference potential for analogue inputs AI
33	AI1	Outside-temperature sensor
32	AI2	Sensor for supply air temperature
31		Reference potential for analogue inputs AI
30	AI3	Frost-protection sensor
29	AI4	Return air temperature

9	DI1	External OFF switch
10	DI2	Frost-protection function
11	DI3	Supply air fan on
12	DI4	Anti-icing function
17		Reference potential for analogue outputs AO
18	AO1	Y1 actuator for heater
19	AO2	Y2 actuator for HRec
20	AO3	Y3 actuator for cooler

5.8.4 RDT828 – Cascade control with CO₂ control

Structure of installation:

- Outside- and exhaust-air dampers
- Air filter
- Fans activated via VFD when VFD is enabled
- Heating coil with pump, regulating valve, frost monitor, return sensor
- Air cooler with regulating valve
- HRec with plate heat exchanger
- Supply air sensor
- Outside and return air sensors
- CO₂ sensor in return air

Closed-loop control functions:

- Temperature control with return air/supply air cascade
- Control of the CO₂ level

Open-loop control functions:

- Start-up circuit
- Filter monitoring
- Free outside air cooling
- Frost monitor
- Sensor monitoring/change-over
- Min./max. limit for inlet temperature
- Motor/air flow monitor
- Anti-jamming facility for pump
- Collective alarm
- Standstill control
- External cooling request
- HRec anti-icing function

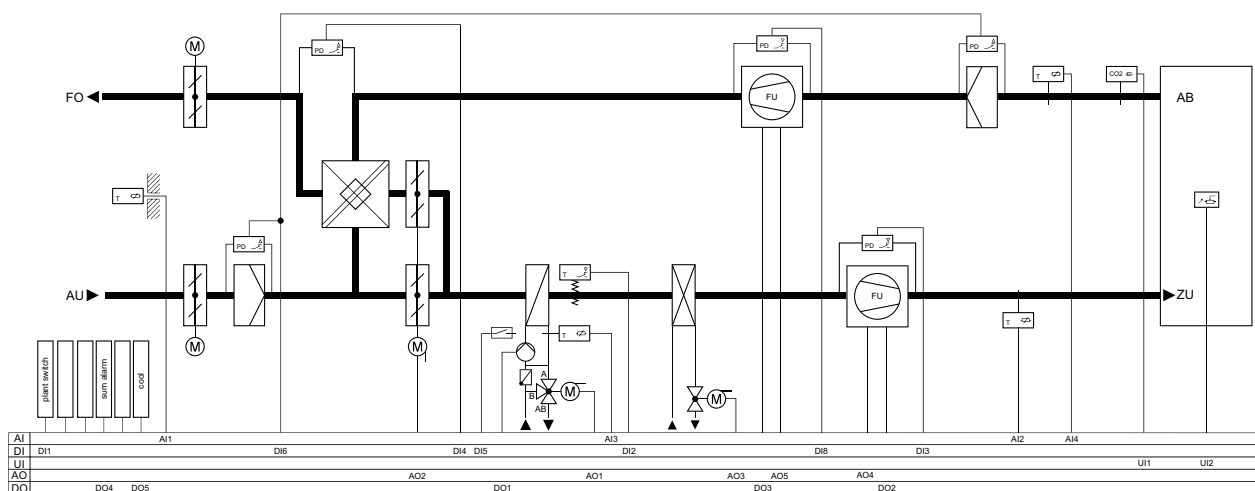

Brief description:

The outside air and exhaust air dampers, along with the HRec bypass valve, are closed when the installation is switched off. The installation can be switched on or off in automatic mode using a time programme or free outside air cooling. If a fault is indicated for the motor/air flow, the frost-protection facility or the supply air sensor, the installation is switched off. A collective alarm can be indicated externally. When air filters are dirty, the filter monitor issues a maintenance message. The monitor for differential pressure on the exhaust air side protects the HRec plate coil from excessive icing.

If the installation is running properly, the temperature control system corrects the variable setpoint via the heating coil, the air cooler and the HRec.

The CO₂ control system increases the speed of the fan according to the CO₂ level.



The cold supply (e.g. supply pump or chiller) is activated using the external contacts for cooling demand. If a wire breaks or there is a short circuit in the room air or return air sensor, the sensor monitoring is activated. The minimum and maximum supply air temperature is then limited. The start-up circuit reduces the risk of faults due to frost when outside temperatures are very low. The standstill control system protects the heating coil in areas not protected from frost.

Terminal assignment:



	LS	Power supply 24 V AC or 24 V DC, ±15%. 50/60 Hz
	MM	
		Earth conductor
43	+24 V	+24 V DC. Reference point for digital inputs DI

1	D+	RS485 Modbus (not for WEB (TCP/IP) models)
2	D-	
3	C	
4	E	

42	LS	Reference point for digital outputs DO
41	DO1	Heating coil pump
40	DO2	Supply air fan for frequency converter enabled
39	DO3	Return air fan for frequency converter enabled
38	DO4	Collective alarm
37	DO5	Cooling demand
36	DO6	Not used
35	DO7	Not used

34		Reference potential for analogue inputs AI
33	AI1	Outside temperature
32	AI2	Supply air temperature
31		Reference potential for analogue inputs AI
30	AI3	Frost-protection sensor
29	AI4	Return air temperature

9	DI1	External OFF switch
10	DI2	Frost-protection function
11	DI3	Supply air fan on
12	DI4	Anti-icing function
13	DI5	Heating coil pump on
14	DI6	Filter monitor
15	DI7	Not used
16	DI8	Return air fan on

28		Reference potential for universal inputs UI
27	UI1	CO2 sensor
26	UI2	Setpoint for room temperature
25		Reference potential for universal inputs UI
24	UI3	Not used
23	UI4	Not used

17		Reference potential for analogue outputs AO
18	AO1	Y1 actuator for heater
19	AO2	Y2 actuator for HRec
20	AO3	Y3 actuator for cooler
21	AO4	Supply air fan
22	AO5	Return air fan

Other functions

5.8.5 RDT828 – Cascade control with humidity control

Structure of installation:

- Outside, recirculated and exhaust air dampers
- Air filter
- Two-speed fans
- Heating coil with pump, regulating valve, frost monitor, motor monitor, return sensor
- Air cooler with regulating valve
- Humidification with pump and regulating valve
- Return air, outside and return air sensors
- Humidity sensor in the return air and supply air

Closed-loop control functions:

- Temperature control with return air/supply air cascade
- Humidity control

Open-loop control functions:

- Start-up circuit
- Fire shut-down
- Filter monitoring
- Free outside air cooling
- Frost monitor
- Sensor monitoring
- Min./max. limit for supply air temperature
- Motor/air flow monitor
- Anti-jamming facility for pump
- Collective alarm
- Standstill control
- External heat and cooling demand

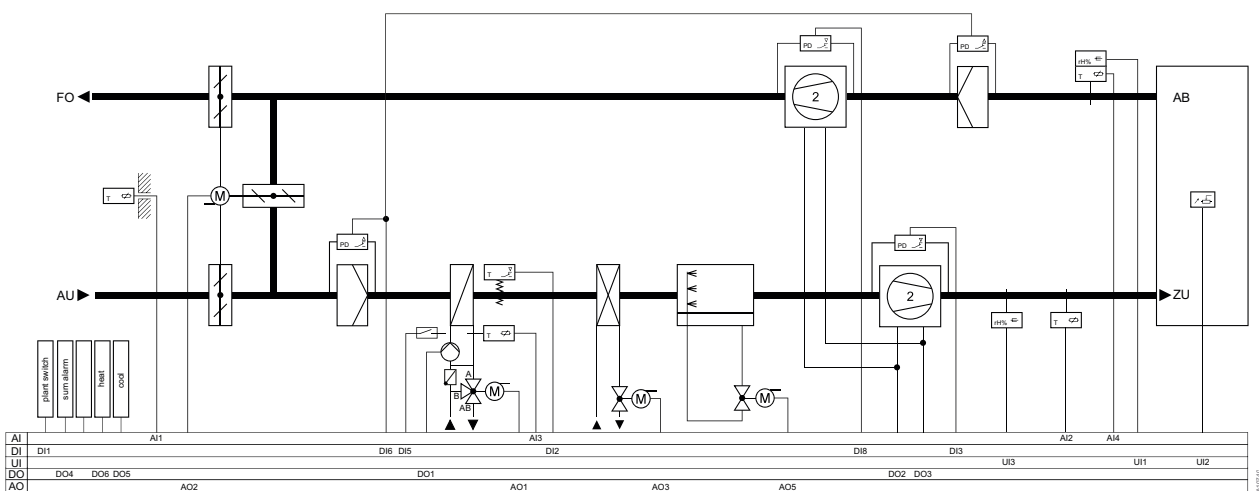

Brief description:

The outside air and exhaust air dampers, along with the HRec bypass valve, are closed when the installation is switched off. The installation can be switched on or off by a time programme in automatic mode, by the free outside air cooling or the cooling-down protection function. If a fault is indicated for the motor/air flow, the frost-protection facility, the supply air sensor or for fire, the installation is switched off. A collective alarm can be indicated externally. When air filters are dirty, the filter monitor issues a maintenance message. The monitor for differential pressure on the exhaust air side protects the HRec plate coil from excessive icing.

If the installation is running properly, the temperature control system corrects the variable setpoint via the heating coil, the air cooler and the HRec. The provision of heat or cold (e.g. supply pump, boiler or chiller) is switched on via the external contacts for heat/cooling demand.

At the same time, the humidity is regulated using a PI controller in accordance with the humidity level in the return air. A sensor in the supply air monitors the maximum humidity value.

The minimum and maximum inlet temperature is then limited. The start-up circuit reduces the risk of faults due to frost when outside temperatures are very low. The standstill control system protects the heating coil in areas not protected from frost.



Other functions

Terminal assignment:



	LS	Power supply 24 V AC or 24 V DC, ±15%. 50/60 Hz
	MM	
		Earth conductor
43	+24 V	+24 V DC. Reference point for digital inputs DI

1	D+	RS485 Modbus (not for WEB (TCP/IP) models)
2	D-	
3	C	
4	E	

42	LS	Reference point for digital outputs DO
41	DO1	Heating coil pump
40	DO2	Supply air fan, level 1
39	DO3	Supply air fan, level 2
38	DO4	Collective alarm
37	DO5	Cooling demand
36	DO6	Heat demand
35	DO7	Not used

34		Reference potential for analogue inputs AI
33	AI1	Outside temperature
32	AI2	Supply air temperature
31		Reference potential for analogue inputs AI
30	AI3	Frost-protection sensor
29	AI4	Return air temperature

9	DI1	External OFF switch
10	DI2	Frost-protection function
11	DI3	Supply air fan on
12	DI4	Not used
13	DI5	Heating coil pump on
14	DI6	Filter monitor
15	DI7	Not used
16	DI8	Return air fan on

28		Reference potential for universal inputs UI
27	UI1	Room humidity
26	UI2	Setpoint for room temperature
25		Reference potential for universal inputs UI
24	UI3	Supply air humidity
23	UI4	Not used

17		Reference potential for analogue outputs AO
18	AO1	Y1 actuator for heater
19	AO2	Y2 actuator for HRec
20	AO3	Y3 actuator for cooler
21	AO4	Not used
22	AO5	Humidity

© Fr. Sauter AG
Im Surinam 55
CH-4016 Basel
Tel. +41 61 - 695 55 55
Fax +41 61 - 695 55 10
www.sauter-controls.com
info@sauter-controls.com